

HEERA MIDDLE EAST COMPANY



شركة هيرا ميدل إيست

Heera Middle East **Company**

CONTACT US



054 772 2446



www.heeramiddleeast.com



info@heeramiddleeast.com

About Us (Introduction)

We are a specialized general contracting company delivering high-quality finishing and decorative works, along with integrated and advanced flooring protection solutions. Built on a strong foundation of engineering expertise and professional project management, we serve residential, commercial, industrial, and warehouse sectors with precision, reliability, and strict commitment to project timelines. Our expertise includes complete interior and exterior finishing works, innovative decorative solutions, high-performance epoxy flooring systems, impact-resistant rubber protection systems, and all types of guidance and traffic signage using phosphorescent materials and solar-powered systems—designed to meet the most demanding operational environments in accordance with the highest standards of quality and safety.

شركة هيرا ميدل إيست
Heera Middle East Company

Who We Are

A team of experienced engineers, project managers, and skilled technicians dedicated to transforming spaces into durable, functional, and aesthetically refined environments.

We combine technical expertise, modern materials, and international standards to achieve superior results.



شركة هيرا ميدل إيست
Heera Middle East Company
0563657274 - 0547722446

Company VISION & Mission

Vision

- To be recognized as a leading contracting company in finishing works and specialized flooring systems, setting new benchmarks in quality, durability, and client satisfaction.

Mission

- To deliver professional, high-quality finishing and flooring solutions through:
- Technical excellence
- Reliable project execution
- Innovative materials and systems
- Strong client partnerships
-

Core Values

- Quality & Precision
- Integrity & Transparency
- Commitment to Deadlines
- Safety & Compliance
- Continuous Improvement



054 772 2446



www.heeramiddleeast.com



info@heeramiddleeast.com

نطاق العمل

Scope of work

شركة هيرا ميدل إيست
Heera Middle East Company
0563657274 - 0547722446

مصعدات السيارات
WHEEL STOPPER
(PARKING BLOCKS)



شركة هيرا ميدل إيست
Heera Middle East Company
0563657274 - 0547722446

الاعمال المعدنية

Metal works

اعمال التخطيط للطرق
ومواقف السيارات

Road and parking
planning works

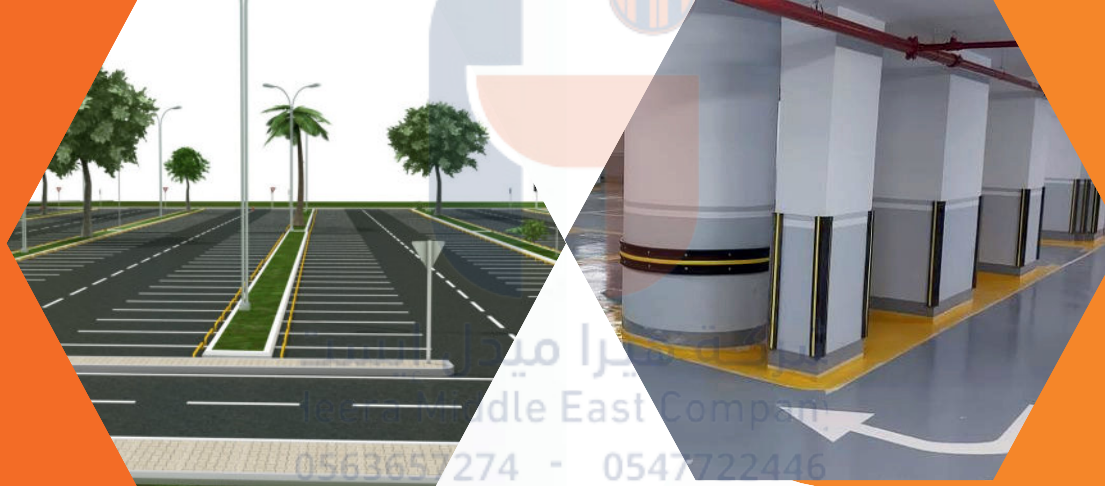

الاكسسوارات والحمايات
المطاطية للمواقف

Accessories and rubber
protections for parking

اعمال صبة سكريد
لارضيات المواقف

Screed works for
parking lot floors



اعمال الايبوكسي
(ارضيات - عزل خزانات)

Epoxy works
(flooring - tank insulation)

اعمال فواصل التمدد
شركة هيرا ميدل إيست
Heera Middle East Company
0563657274 - 0547722446

Expansion joints



شركة هيرا ميدل إيست
Heera Middle East Company
0563657274 - 0547722446

اللافتات الارشادية

Directional signs

المرايا المقعرة

Concave mirrors



اعمال الاسفلت

Asphalt works

المطبات الصناعية

Speed bumps



حماية الحوائط واركان
الاعمدة

Protection of walls
and column corners

اعمال الترقيم وتحديد
المسار

NUMPERING work and
route determination



سيراميك الطرق
الفوسفوري عيون القط

Phosphorescent road
tiles, cat's eyes

نطاق العمل

Scope of work



شركة هيرا ميدل إيست
Heera Middle East Company

شركة هيرا ميدل إيست
Heera Middle East Company
0563657274 - 0547722446

أعمال الألمونيوم
Aluminum works



شركة هيرا ميدل إيست
Heera Middle East Company
0563657274 - 0547722446

مصدات الخرسانة
Concrete car Stoppers

تجاليد حوائط بديل الرخام
Marble alternative wall panels

تجاليد حوائط بديل الرخام
Marble alternative wall panels



بلدورات خرسانية
Concrete Curbstones

بلدورات خرسانية
Concrete Curbstones

باركية ارضيات
Parquet Flooring

باركية ارضيات
Parquet Flooring

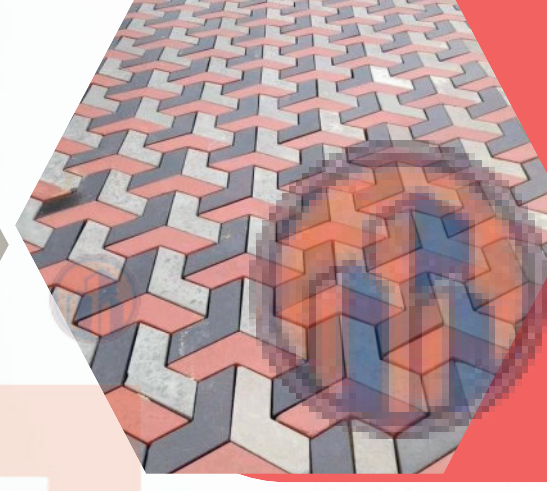

بلاط انترلوك
Interlock tiles

بلاط انترلوك
Interlock tiles

تجاليد حوائط بديل خشب
Wood alternative wall panels

تجاليد حوائط بديل خشب
Wood alternative wall panels



أعمال تنسيق الحدائق
Landscape works

أعمال تنسيق الحدائق
Landscape works

تجاليد حوائط بديل الحجر
Wall cladding stone alternative

تجاليد حوائط بديل الحجر
Wall cladding stone alternative



نظام الخرسانة مسبقة الصب
Precast Concrete SYSTEM

نظام الخرسانة مسبقة الصب
Precast Concrete SYSTEM

تجاليد حوائط بديل الشيبورد
Wall cladding chipboard alternative

تجاليد حوائط بديل الشيبورد
Wall cladding chipboard alternative



أنظمة واجهة GRB
GRP Facade Systems

أنظمة واجهة GRB
GRP Facade Systems

أنظمة واجهة GRC
GRC Facade Systems

أنظمة واجهة GRC
GRC Facade Systems



أعمال العزل
Insulation Works

أعمال العزل
Insulation Works



RUBBER CORNER GUARDS EPDM

Product Description

EPDM Rubber Corner Guards are flexible protective profiles designed to protect corners, edges, and structural surfaces from impact, abrasion, and wear. They are widely used in industrial, commercial, and parking applications due to their excellent weather and aging resistance.

- **Material: High-quality EPDM Rubber**

Purpose: Protection of corners and edges against impact and abrasion

Color: Black (other colors available upon request)

,Available in 90° angle with standard lengths of 1, 2 and 3 meters, and leg widths of 50×50, 75×75, and .mm 100×100

Different thicknesses and custom sizes are available upon request

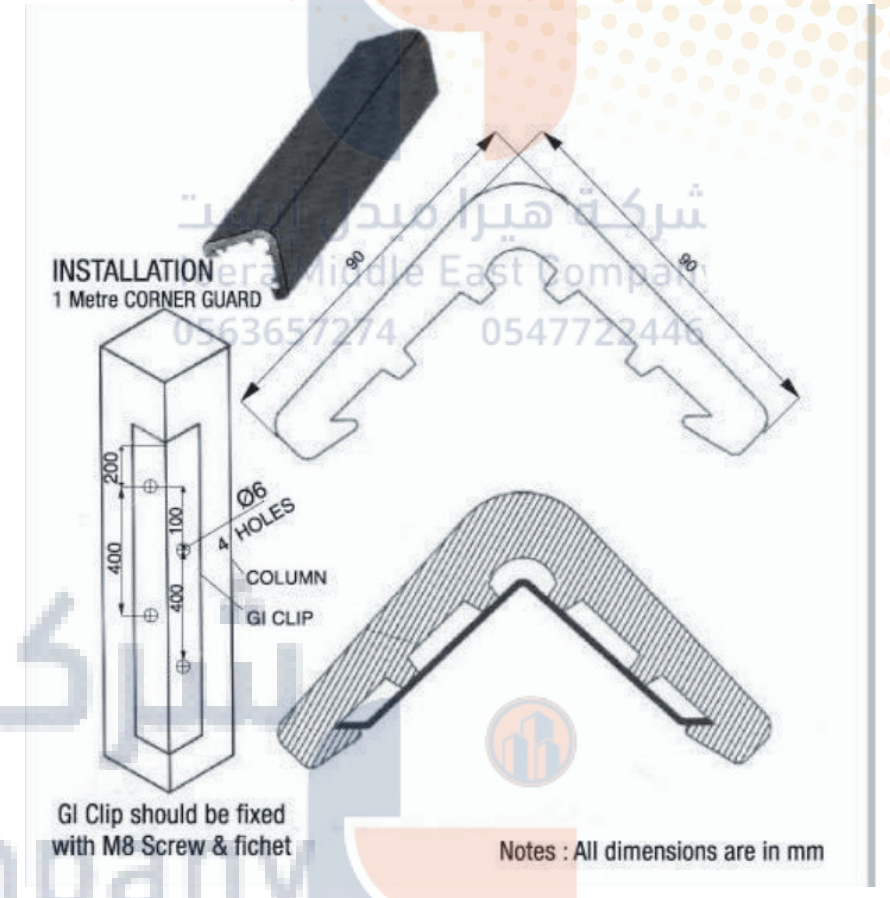

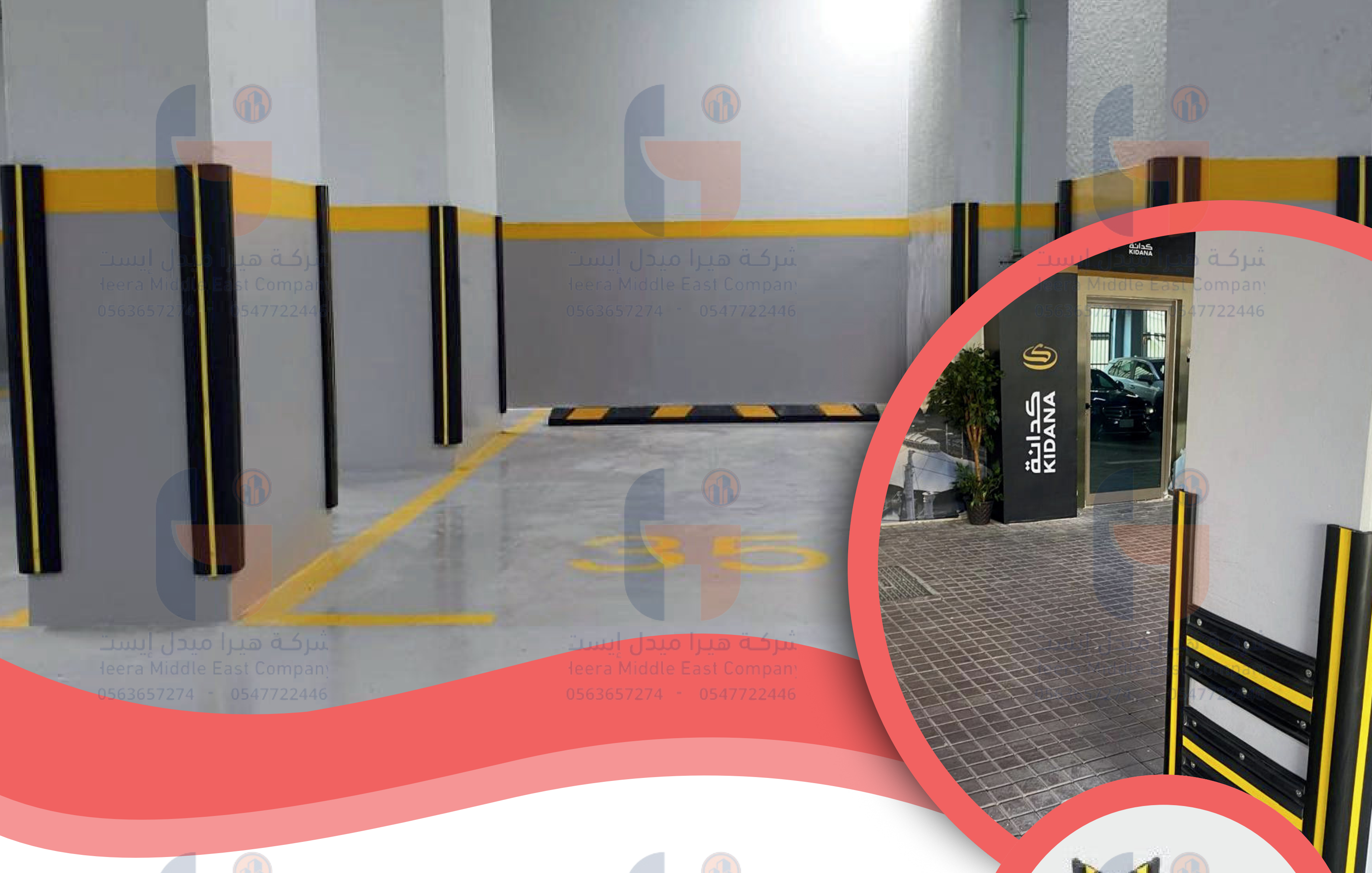

RUBBER CORNER GUARDS EPDM

Installation

Easy to install using mechanical fixings or industrial adhesive on concrete, steel, or wall surfaces.

Provides secure and long-lasting protection with minimal maintenance

Importance & Advantages

Rubber corner guards protect building corners and edges from impact damage, extending surface life and reducing maintenance costs. They offer high impact absorption, durability, and excellent resistance to weather and outdoor conditions.



RUBBER WALL GUARDS EPDM

شركة هيرا ميدل إيست
Jeera Middle East Company
0563657274 - 0547722446

01 Description

EPDM rubber wall guards are designed to protect walls and surfaces from impact, abrasion, and damage in high-traffic areas.

شركة هيرا ميدل إيست
Jeera Middle East Company
0563657274 - 0547722446

شركة هيرا ميدل إيست
Jeera Middle East Company
0563657274 - 0547722446

02 Material

- High-quality EPDM rubber
- Flexible, durable, and impact resistant
- Excellent resistance to weather, UV, and aging

03 Standard Sizes

- Standard lengths: 1,000 / 2,000 / 3,000 mm
- Thickness: 8 – 15 mm
- Height / Width: as per standard profiles or project requirements

04 Installation

- Easy installation using mechanical fixings or industrial adhesive
- Suitable for concrete, blockwork, drywall, and steel surfaces

شركة هيرا ميدل إيست
Jeera Middle East Company
0563657274 - 0547722446

شركة هيرا ميدل إيست
Jeera Middle East Company
0563657274 - 0547722446

شركة هيرا ميدل إيست
Jeera Middle East Company
0563657274 - 0547722446

شركة هيرا ميدل إيست
Jeera Middle East Company
0563657274 - 0547722446

شركة هيرا ميدل إيست
Jeera Middle East Company
0563657274 - 0547722446

شركة هيرا ميدل إيست
Jeera Middle East Company
0563657274 - 0547722446



054 772 2446



www.heeramiddleeast.com



info@heeramiddleeast.com



RUBBER WALL GUARDS EPDM

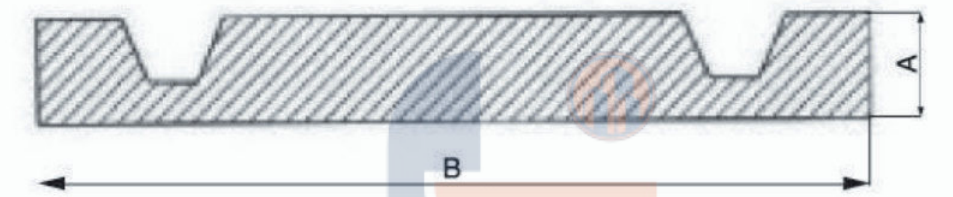

شركة هيرا ميدل إيست
Heera Middle East Company
0563657274 - 0547722446



Importance

- Rubber wall guards made from EPDM are designed to absorb impacts, protect walls from damage, and are ideal for use in industrial and commercial environments.
- Key Features of EPDM Rubber Wall Guards

Applications

- **Industrial Settings:** Ideal for loading docks, warehouse perimeters, and industrial corridors where heavy traffic occurs.
- **Commercial Use:** Commonly used in parking garages and service areas to protect walls from collisions and abrasions caused by moving objects.
- **Corner Protection:** EPDM wall guards can also be used to protect corners and edges of walls, enhancing safety in high-traffic areas.

Advantages

- Protects walls from damage and reduces maintenance costs
- High impact absorption and long service life
- Suitable for indoor and outdoor applications



SAFTY USAGE FOR SPEED HUPS

RUBBER CAR SPEED HUMPS EPDM

Description

EPDM rubber speed humps are traffic-calming devices designed to control vehicle speed and improve safety in parking areas and roadways.

Material

- High-quality EPDM rubber
- Heavy-duty, flexible, and impact resistant
- Excellent resistance to weather, UV, and aging

Standard Sizes

- Standard length modules: 500 mm / 1,000 mm
- Width: approx. 350 – 400 mm
- Height: approx. 50 – 75 mm
- Modular design allows customized lengths

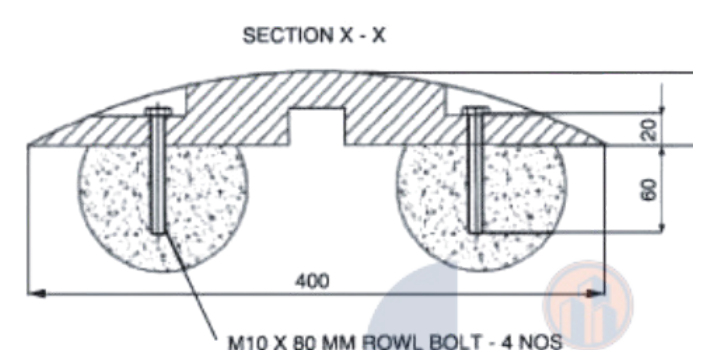
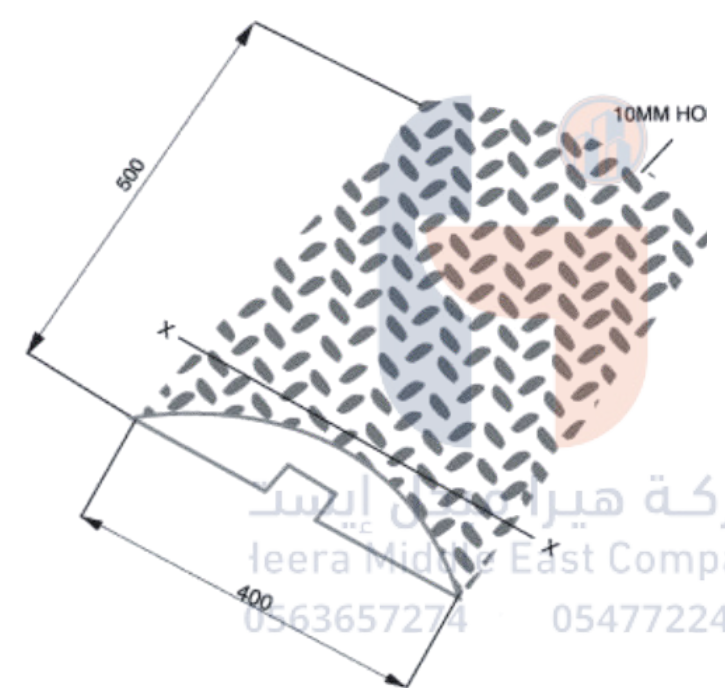



SAFTY USAGE FOR SPEED HUMPS

RUBBER CAR SPEED HUMPS EPDM



Installation

- Fixed to asphalt or concrete surfaces using anchor bolts
- Easy and quick installation with minimal maintenance

Importance & Advantages

- Reduces vehicle speed and enhances pedestrian safety
- High load-bearing capacity and long service life
- Resistant to outdoor conditions and heavy traffic
- Suitable for parking areas, residential compounds, and commercial zones



شركة هيرا ميدل إيست
Heera Middle East Company

054 772 2446

www.heeramiddleeast.com

info@heeramiddleeast.com



RUBBER CAR STOPPER

Description

- EPDM rubber car stoppers are designed to prevent vehicles from overrunning parking spaces and to protect walls, curbs, and other vehicles.

MATERIAL

- High-quality EPDM rubber
- Heavy-duty, flexible, and in
- Excellent resistance to wear

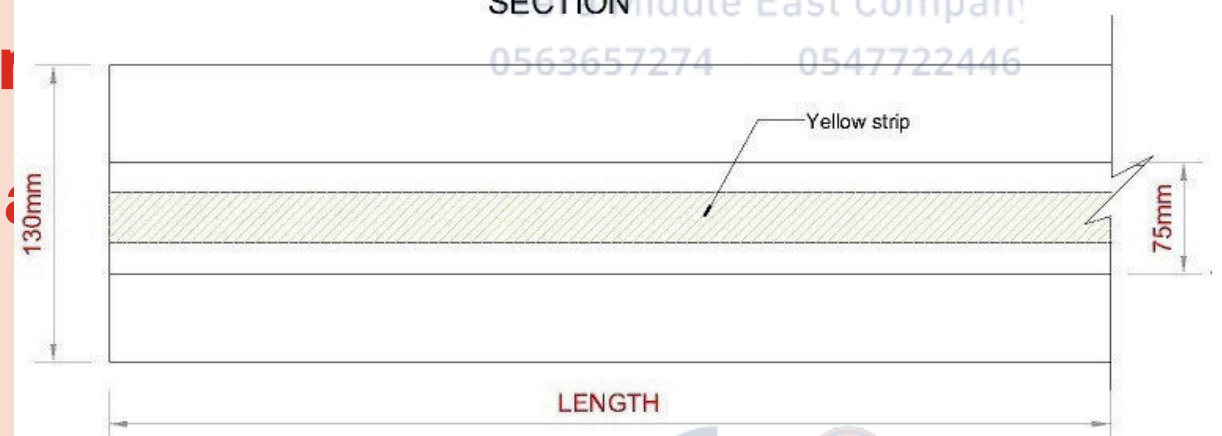
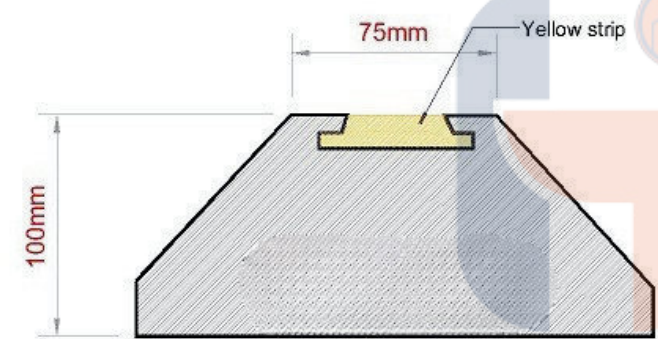

STANDARD SIZES

- Typical length: 1,800 mm (modular lengths available)
- Width: approx. 150 – 200 mm
- Height: approx. 100 – 150 mm
- Reflective strips available for visibility



054 772 2446



www.heeramiddleeast.com



info@heeramiddleeast.com

شركة هيرا ميدل إيست
Heera Middle East Company
0563657274 - 0547722446

شركة هيرا ميدل إيست
Heera Middle East Company
0563657274 - 0547722446

شركة هيرا ميدل إيست
Heera Middle East Company
0563657274 - 0547722446

شركة هيرا ميدل إيست
Heera Middle East Company
0563657274 - 0547722446

شركة هيرا ميدل إيست
Heera Middle East Company
0563657274 - 0547722446

شركة هيرا ميدل إيست
Heera Middle East Company
0563657274 - 0547722446



RUBBER CAR STOPPER

INSTALLATION

- Installed on concrete or asphalt surfaces using anchor bolts
- Quick and secure installation with low maintenance

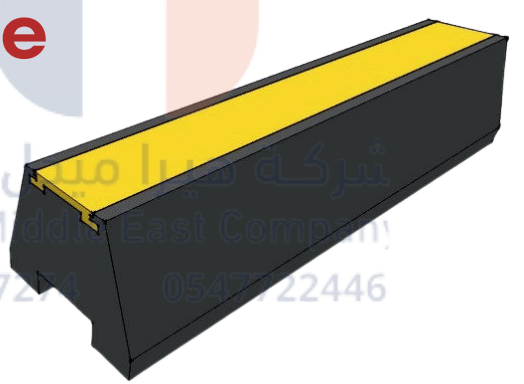

IMPORTANCE & ADVANTAGES

- Improves parking safety and vehicle positioning
- Protects structures and vehicles from impact damage
- Durable, long service life, and suitable for outdoor use
- High visibility and resistance to heavy vehicle loads

شركة هيرا ميدل إيست
Heera Middle East Company
0563657274 - 0547722446

شركة هيرا ميدل إيست
Heera Middle East Company
0563657274 - 0547722446

شركة هيرا ميدل إيست
Heera Middle East Company
0563657274 - 0547722446



054 772 2446



www.heeramiddleeast.com



info@heeramiddleeast.com

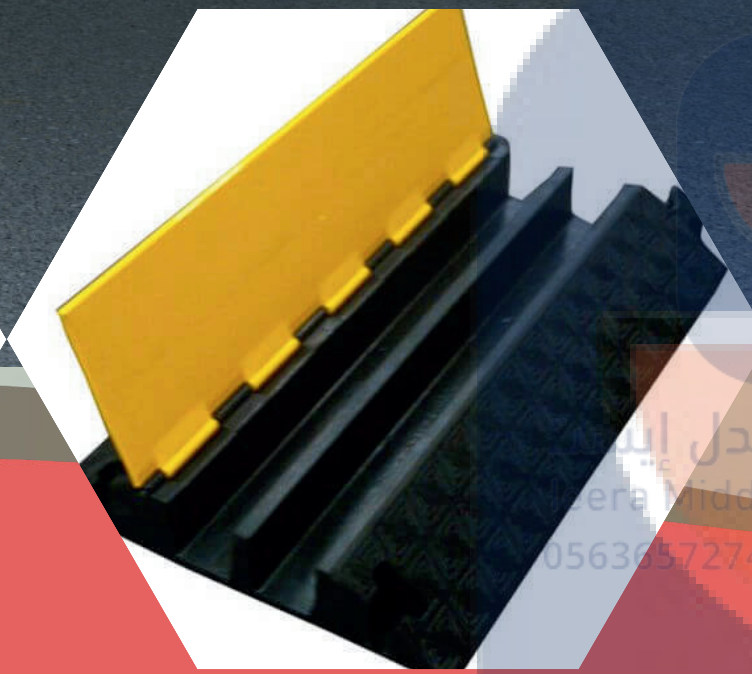

RUBBER CAR SPEED HUMPS (CHINESE-MADE) DESCRIPTION

✓ CHINESE-MADE RUBBER SPEED HUMPS DESIGNED TO REDUCE VEHICLE SPEED AND IMPROVE TRAFFIC SAFETY IN PARKING AREAS, RESIDENTIAL ROADS, INDUSTRIAL ZONES, AND PRIVATE DEVELOPMENTS.

MATERIAL

- ✓ HIGH-QUALITY RECYCLED RUBBER
- ANTI-SKID SURFACE WITH TEXTURED FINISH
- HIGH-VISIBILITY REFLECTIVE INSERTS (YELLOW/WHITE)
- UV AND WEATHER-RESISTANT MATERIAL SUITABLE FOR OUTDOOR USE

شركة هيرا ميدل إيست
Heera Middle East Company
0563657274 - 0547722446

شركة هيرا ميدل إيست
Heera Middle East Company
0563657274 - 0547722446

شركة هيرا ميدل إيست
Heera Middle East Company
0563657274 - 0547722446

شركة هيرا ميدل إيست
Heera Middle East Company
0563657274 - 0547722446

شركة هيرا ميدل إيست
Heera Middle East Company
0563657274 - 0547722446

شركة هيرا ميدل إيست
Heera Middle East Company
0563657274 - 0547722446

RUBBER WALL CORNER GUARD PROTECTOR

Total Length :
1205 mm * 140 mm * 95 mm
Thickness : 10 mm Weight : 4.5 kg

Total Length :
780 mm * 100 mm * 85 mm
Thickness : 8 mm Weight : 900 g

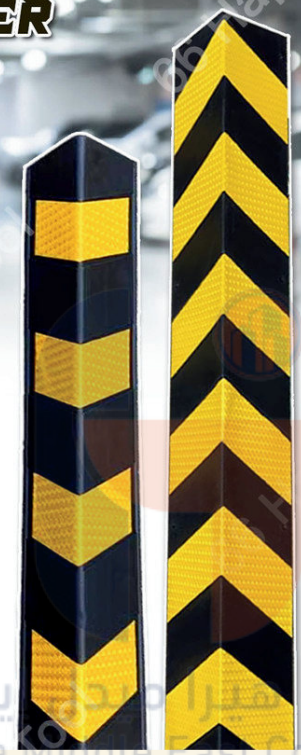

شركة هيرا ميدل إيست
Heera Middle East Company

شركة هيرا ميدل إيست
Heera Middle East Company

شركة هيرا ميدل إيست
Heera Middle East Company

RUBBER CORNER GUARD (CHINESE-MADE)

DESCRIPTION

Chinese-made rubber corner guards designed to protect wall corners and columns in parking areas, warehouses, and industrial facilities from vehicle and impact damage.

MATERIAL

- High-quality recycled rubber
- Flexible, impact-absorbing material
- High-visibility yellow reflective stripes or reflective inserts
- UV-resistant and weatherproof surface

STANDARD SIZES

- Length: 800 mm / 1000 mm / 1200 mm
- Width: 80 - 120 mm (per side)
- Thickness: 10 - 20 mm



054 772 2446



www.heeramiddleeast.com



info@heeramiddleeast.com





شركة هيرا ميدل إيست
Heera Middle East Company

شركة هيرا ميدل إيست
Heera Middle East Company

0563657274 - 0547722446



EBOXY PAINT FOR INTERLOCK

MADE FROM DURABLE HEAVY DUTY RUBBER, LONG LASTING WHEEL STOPPER



SIZE :- 1830 MM x 150 MM x 100 MM



SIZE :- 900 MM x 150 MM x 100 MM



SIZE :- 550 MM x 150 MM x 100 MM

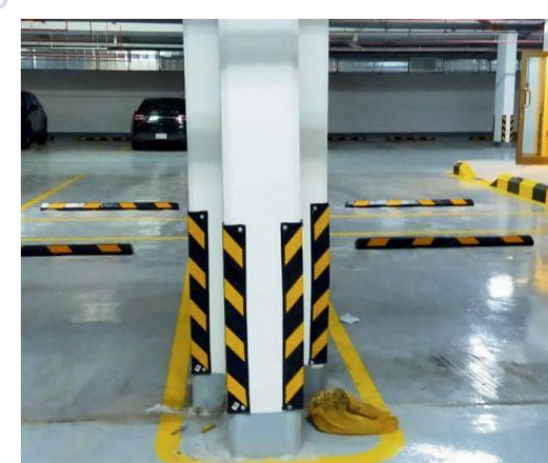

RUBBER CAR STOPPER (CHINESE-MADE)

DESCRIPTION

Rubber car stoppers manufactured in China, designed to prevent vehicles from moving beyond designated parking spaces, protect structures and vehicles, and improve parking safety and organization.

MATERIAL

- High-quality recycled rubber or EPDM rubber (Chinese manufacturing standard)
- Reinforced with internal steel rebar or composite insert (where applicable)
- Optional high-visibility reflective strips (yellow/white) for enhanced visibility

شركة هيرا ميدل إيست
Heera Middle East Company
0563657274 - 0547722446

شركة هيرا ميدل إيست
Heera Middle East Company
0563657274 - 0547722446

شركة هيرا ميدل إيست
Heera Middle East Company
0563657274 - 0547722446



054 772 2446



www.heeramiddleeast.com



info@heeramiddleeast.com



شركة هيرا ميدل إيست
Heera Middle East Company

شركة هيرا ميدل إيست
Heera Middle East Company
0563657274 - 0547722446



RUBBER CAR STOPPER (CHINESE-MADE)

STANDARD SIZES

- Length: 500 mm / 1000 mm / 1800 mm (modular options)
- Width: 150 - 200 mm
- Height: 90 - 120 mm
- Custom sizes available upon request

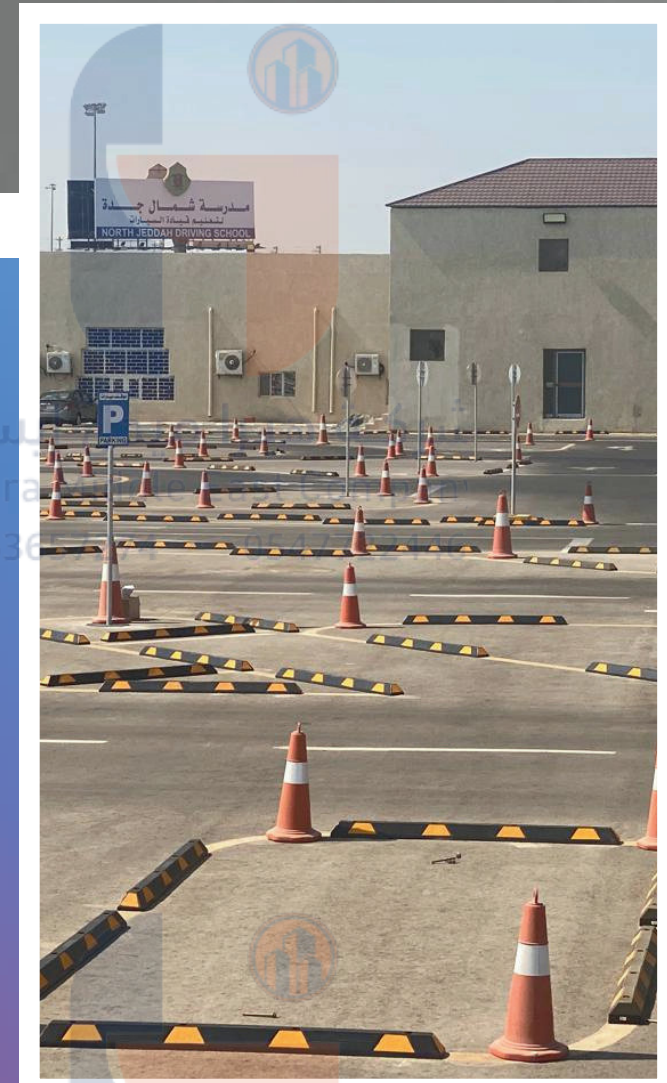
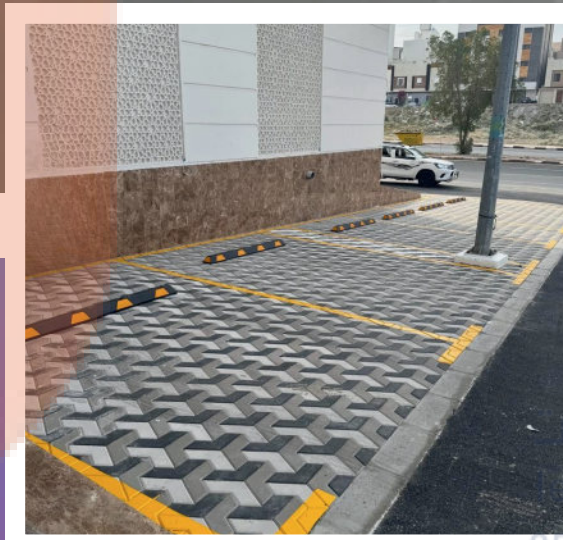

INSTALLATION

- Installed on concrete or asphalt surfaces using anchor bolts
- Simple and quick installation with pre-drilled holes
- Rubber base resists movement and impact once fixed

شركة هيرا ميدل إيست
Heera Middle East Company
0563657274 - 0547722446

شركة هيرا ميدل إيست
Heera Middle East Company
0563657274 - 0547722446

شركة هيرا ميدل إيست
Heera Middle East Company
0563657274 - 0547722446



054 772 2446



www.heeramiddleeast.com



info@heeramiddleeast.com



EPOXY WORKS (FLOORING & TANK INSULATION)

Description

Epoxy works include the application of high-performance epoxy systems for floor protection and tank insulation, providing seamless, durable, and chemical-resistant surfaces.

شركة هيرا ميدل إيست
Heera Middle East Company

شركة هيرا ميدل إيست
Heera Middle East Company
0563657274 - 0547722446

شركة هيرا ميدل إيست
Heera Middle East Company
0563657274 - 0547722446

شركة هيرا ميدل إيست
Heera Middle East Company
0563657274 - 0547722446

054 772 2446

www.heeramiddleeast.com

info@heeramiddleeast.com

WE ARE ADVANCED

EPOXY WORKS FLOORING & TANK INSULATION



شركة هيرا ميدل إيست
Heera Middle East Company
0563657274 - 0547722446

MATERIAL



- Two-component epoxy resin system



- High adhesion to concrete and steel surfaces



- Resistant to chemicals, moisture, and abrasion



STANDARD THICKNESS / SIZE



- Flooring epoxy thickness: 2 – 4 mm



- Tank epoxy lining thickness: 3 – 5 mm

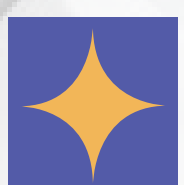

- Applied as a continuous seamless coating

INSTALLATION



- Surface preparation by grinding or shot blasting

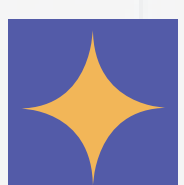

- Application of epoxy primer, body coat, and top coat



- Applied by roller or trowel as per system requirements



054 772 2446



www.heeramiddleeast.com



info@heeramiddleeast.com

شركة هيرا ميدل إيست
Heera Middle East Company
0563657274 - 0547722446

شركة هيرا ميدل إيست
Heera Middle East Company
0563657274 - 0547722446

شركة هيرا ميدل إيست
Heera Middle East Company
0563657274 - 0547722446



شركة هيرا ميدل إيست
Heera Middle East Company
0563657274 - 0547722446

شركة هيرا ميدل إيست
Heera Middle East Company
0563657274 - 0547722446

شركة هيرا ميدل إيست
Heera Middle East Company
0563657274 - 0547722446

شركة هيرا ميدل إيست
Heera Middle East Company
0563657274 - 0547722446

شركة هيرا ميدل إيست
Heera Middle East Company
0563657274 - 0547722446

شركة هيرا ميدل إيست
Heera Middle East Company
0563657274 - 0547722446

شركة هيرا ميدل إيست
Heera Middle East Company
0563657274 - 0547722446

شركة هيرا ميدل إيست
Heera Middle East Company
0563657274 - 0547722446

شركة هيرا ميدل إيست
Heera Middle East Company
0563657274 - 0547722446

EPOXY WORKS FLOORING & TANK INSULATION

IMPORTANCE & ADVANTAGES:

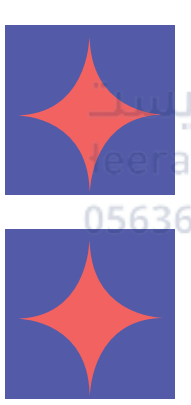

- Provides durable, waterproof, and hygienic surfaces
- Protects concrete and steel from chemical attack and corrosion

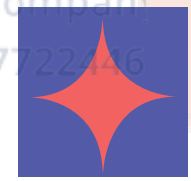

- Easy to clean, long service life, and low maintenance

شركة هيرا ميدل إيست
Heera Middle East Company

شركة هيرا ميدل إيست
Heera Middle East Company
0563657274 - 0547722446

شركة هيرا ميدل إيست
Heera Middle East Company
0563657274 - 0547722446

شركة هيرا ميدل إيست
Heera Middle East Company
0563657274 - 0547722446



054 772 2446



www.heeramiddleeast.com



info@heeramiddleeast.com



شركة هيرا ميدل إيست
Jeera Middle East Company
0563657274 - 0547722446

شركة هيرا ميدل إيست
Jeera Middle East Company
0563657274 - 0547722446

شركة هيرا ميدل إيست
Jeera Middle East Company
0563657274 - 0547722446

شركة هيرا ميدل إيست
Jeera Middle East Company
0563657274 - 0547722446

شركة هيرا ميدل إيست
Jeera Middle East Company
0563657274 - 0547722446

شركة هيرا ميدل إيست
Jeera Middle East Company
0563657274 - 0547722446

شركة هيرا ميدل إيست
Jeera Middle East Company
0563657274 - 0547722446

شركة هيرا ميدل إيست
Jeera Middle East Company
0563657274 - 0547722446

شركة هيرا ميدل إيست
Jeera Middle East Company
0563657274 - 0547722446

Type	Main Applications	Typical Thickness	Advantages	Notes
Self-Leveling Epoxy	Factories, hospitals, parking areas	2 - 5 mm	Smooth finish, aesthetic look, easy to clean	Requires well-prepared level surface
Anti-Slip Epoxy	Ramps, wet areas, industrial zones	2 - 4 mm	High safety, slip-resistant surface	Slightly rough texture
Heavy-Duty Epoxy	Warehouses, heavy industries	3 - 6 mm	High load and impact resistance	Higher cost than standard systems
Decorative Epoxy (Flake / 3D)	Showrooms, offices, malls	2 - 4 mm	Attractive decorative finishes	Mostly for light to medium traffic
Anti-Static / ESD Epoxy	Electronics factories, server rooms	2 - 3 mm	Prevents static electricity buildup	Requires grounding system

شركة هيرا ميدل إيست
Jeera Middle East Company
0563657274 - 0547722446

شركة هيرا ميدل إيست
Jeera Middle East Company
0563657274 - 0547722446

شركة هيرا ميدل إيست
Jeera Middle East Company
0563657274 - 0547722446



054 772 2446



www.heeramiddleeast.com



info@heeramiddleeast.com



شركة هيرا ميديل إيست
Heera Middle East Company
Heera Middle East Company
0563657274 - 0547722446



EBOXY MARKING SIGNS

Road marking works include the application of pavement markings on roads, highways, and parking areas to regulate traffic, guide drivers, and enhance road safety in accordance with approved standards.



MATERIAL

- ✓ Thermoplastic road marking material
- ✓ Cold plastic or traffic paint (where applicable)
- ✓ Glass beads for reflectivity
- ✓ Primer as required

planing

ways defermine

numbering

spiny bumps



054 772 2446

www.heeramiddleeast.com

info@heeramiddleeast.com

TRAFFIC SAFETY CONCAVE MIRROR

شركة هيرا ميدل إيست
Heera Middle East Company

شركة هيرا ميدل إيست
Heera Middle East Company

شركة هيرا ميدل إيست
Heera Middle East Company
0563657274 - 0547722446

- WE SUPPLY AND INSTALL HIGH-QUALITY TRAFFIC SAFETY CONVEX MIRRORS DESIGNED TO ENHANCE VISIBILITY AND REDUCE ACCIDENTS IN BLIND SPOTS, ENTRANCES, EXITS, AND PARKING AREAS.
- THE MIRROR FEATURES A HIGH-CLARITY ACRYLIC CONVEX REFLECTIVE LENS, IMPACT-RESISTANT AND WEATHERPROOF, WITH A DURABLE OUTER HOUSING AND PROTECTIVE TOP HOOD. THE FRAME COMES IN A YELLOW AND BLACK COMBINATION TO ENSURE MAXIMUM VISIBILITY AND WARNING EFFECT.

شركة هيرا ميدل إيست
Heera Middle East Company
0563657274 - 0547722446

شركة هيرا ميدل إيست
Heera Middle East Company
0563657274 - 0547722446

TECHNICAL SPECIFICATIONS:

- HIGH-REFLECTIVE ACRYLIC CONVEX LENS
- UV-RESISTANT AND IMPACT-RESISTANT BODY
- CIRCULAR DESIGN WITH PROTECTIVE TOP COVER
- SMOOTH SURFACE WITH SAFE ROUNDED EDGES
- STRONG MOUNTING BRACKET WITH CORROSION-RESISTANT FASTENERS
- ADJUSTABLE LEFT AND RIGHT POSITIONING

APPLICATIONS:

- PARKING ENTRANCES AND EXITS
- WAREHOUSES AND FACTORIES
- INTERNAL ROADS AND COMPOUNDS
- INTERSECTIONS WITH LIMITED VISIBILITY
- WE ARE COMMITTED TO SUPPLYING PRODUCTS THAT MEET SAFETY STANDARDS, WITH PROFESSIONAL INSTALLATION ENSURING DURABILITY AND LONG-TERM PERFORMANCE.

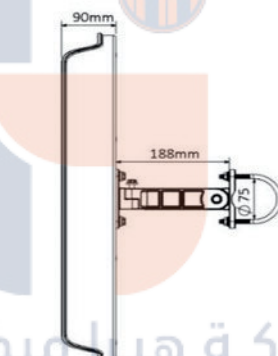
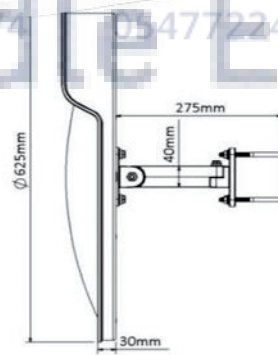

شركة هيرا ميدل إيست
Heera Middle East Company
0563657274 - 0547722446

شركة هيرا ميدل إيست
Heera Middle East Company
0563657274 - 0547722446

شركة هيرا ميدل إيست
Heera Middle East Company
0563657274 - 0547722446

054 772 2446

www.heeramiddleeast.com

info@heeramiddleeast.com

شركة هيرا ميديل إيست
Jeera Middle East Company
0563657274 - 0547722446

شركة هيرا ميديل إيست
Jeera Middle East Company
0563657274 - 0547722446

شركة هيرا ميديل إيست
Jeera Middle East Company
0563657274 - 0547722446



شركة هيرا ميديل إيست
Jeera Middle East Company
0563657274 - 0547722446

شركة هيرا ميديل إيست
Jeera Middle East Company
0563657274 - 0547722446

شركة هيرا ميديل إيست
Jeera Middle East Company
0563657274 - 0547722446

Insulation Works

Types of Insulation

- ✓ **Water proofing**
 - Bituminous membranes (APP / SBS)
 - Cementitious waterproofing
 - Polyurethane spray foam
 - Epoxy and polymer-based coatings
 - Used for roofs, wet areas, tanks, and basements

- ✓ **Damp Proofing**
 - Bituminous coatings
 - Damp-proof membranes
 - Used for foundations and underground walls

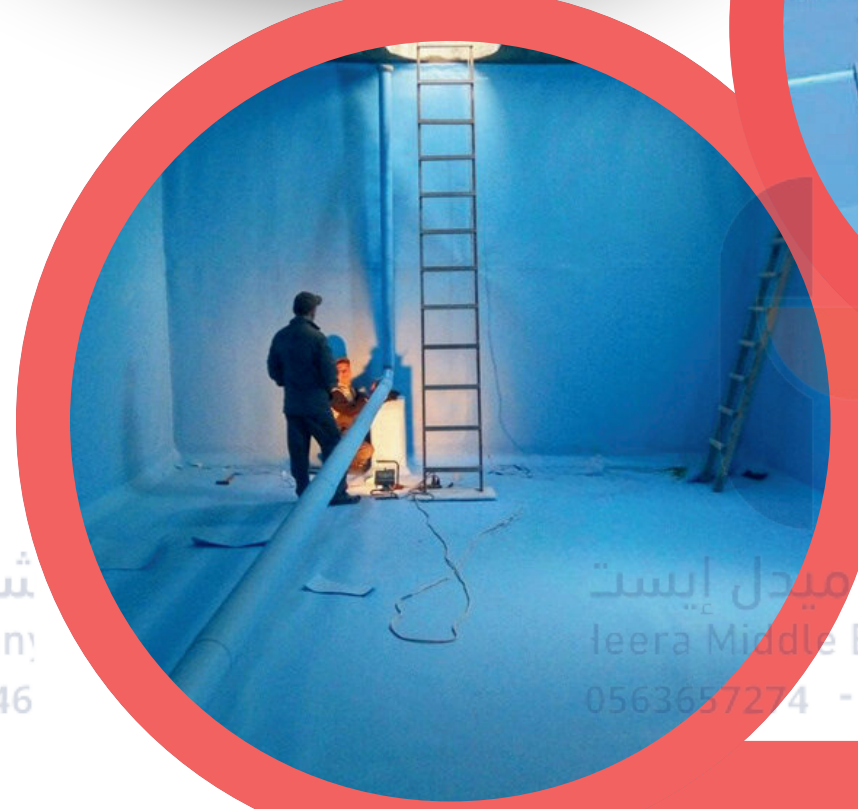

شركة هيرا ميديل إيست
Jeera Middle East Company

شركة هيرا ميديل إيست
Jeera Middle East Company

شركة هيرا ميديل إيست
Jeera Middle East Company

054 772 2446

www.heeramiddleeast.com

info@heeramiddleeast.com



Insulation Works

شركة هيرا ميدل إيست
Ieera Middle East Company
0563657274 - 0547722446

شركة هيرا ميدل إيست
Ieera Middle East Company
0563657274 - 0547722446

شركة هيرا ميدل إيست
Ieera Middle East Company
0563657274 - 0547722446

Types of Insulation

✓ Thermal Insulation:

- ✓ Extruded / Expanded Polystyrene (XPS / EPS)
- ✓ Polyurethane foam
- ✓ Polyurethane spray foam
- ✓ Rock wool
- ✓ Compliant with SBC energy efficiency requirements

✓ Execution Requirements:

- ✓ Proper surface preparation and priming
- ✓ Use of approved materials complying with SBC
- ✓ Mandatory testing (e.g., flood test) before handover
- ✓ Protection of insulation layers after application



Admixture Waterproofing



Epoxy Waterproofing



Acrylic Waterproofing



HDPE Waterproofing

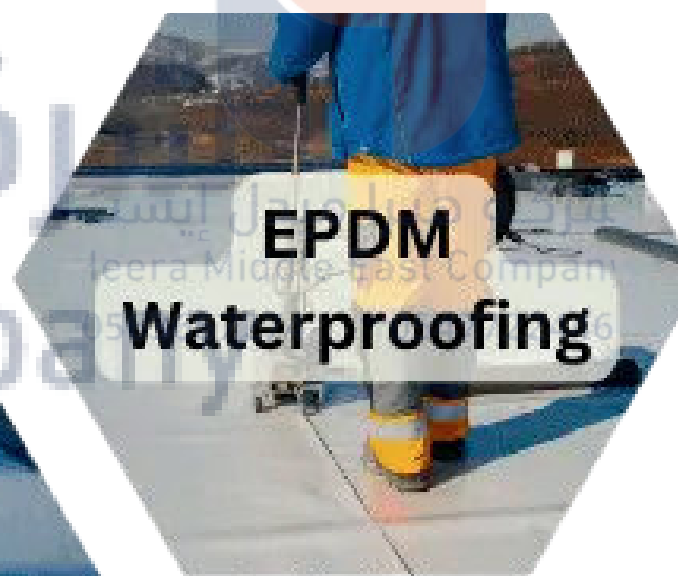

EPDM Waterproofing



PVC Waterproofing



Polimer Waterproofing

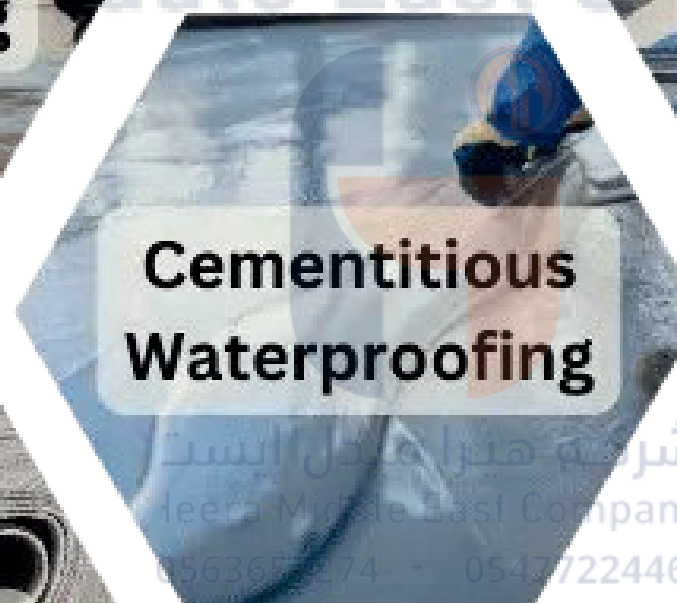

Cementitious Waterproofing



Bituminous Waterproofing

شركة هيرا ميدل إيست
Ieera Middle East Company
0563657274 - 0547722446

شركة هيرا ميدل إيست
Ieera Middle East Company
0563657274 - 0547722446

شركة هيرا ميدل إيست
Ieera Middle East Company
0563657274 - 0547722446



شركة هيرا ميدل إيست
Heera Middle East Company



0563657274 - 0547722446



0563657274 - 0547722446



0563657274 - 0547722446

ASPHALT WORKS

DESCRIPTION

Asphalt works include the supply, laying, and compaction of asphalt concrete for roads, bridges, and parking areas to provide durable and smooth driving surfaces



MATERIAL

- Hot mix asphalt (HMA) complying with project and local authority standards
- Bitumen binder of approved grade
- Crushed aggregates with proper gradation

STANDARD THICKNESS

- Wearing course: 40 – 50 mm
- Binder course: 50 – 70 mm
- Thickness as per design and traffic load



0563657274 - 0547722446

054 772 2446



www.heeramiddleeast.com



info@heeramiddleeast.com

0563657274 - 0547722446

0563657274 - 0547722446



شركة هيرا ميدل إيست
Heera Middle East Company



INSTALLATION

- Surface preparation and cleaning
- Application of prime coat / tack coat
- Laying by asphalt paver and compaction using rollers

IMPORTANCE & ADVANTAGES



- Smooth, skid-resistant, and durable surface



- Withstands heavy traffic and weather conditions



- Long service life with low maintenance



شركة هيرا ميدل إيست
Heera Middle East Company
0563657274 - 0547722446

شركة هيرا ميدل إيست
Heera Middle East Company
0563657274 - 0547722446

شركة هيرا ميدل إيست
Heera Middle East Company
0563657274 - 0547722446

054 772 2446

www.heeramiddleeast.com

info@heeramiddleeast.com



شركة هيرا ميدل إيست
Heera Middle East Company
Heera Middle East Company
0563657274 - 0547722446



شركة هيرا ميدل إيست
Heera Middle East Company
Heera Middle East Company
0563657274 - 0547722446



ROAD MARKING SIGNS

شركة هيرا ميدل إيست
Heera Middle East Company
Heera Middle East Company
0563657274 - 0547722446

شركة هيرا ميدل إيست
Heera Middle East Company
Heera Middle East Company
0563657274 - 0547722446



INSTALLATION

- ✓ • Surface cleaning and preparation prior to application
- ✓ • Applied by spray or screed machines on asphalt or concrete surfaces
- ✓ • Reflective glass beads applied during installation

IMPORTANCE & ADVANTAGES:

- ✓ • Improves traffic guidance and parking organization
- ✓ • Enhances visibility day and night
- ✓ • Durable, skid-resistant, and low maintenance



شركة هيرا ميدل إيست
Heera Middle East Company
Heera Middle East Company
0563657274 - 0547722446

شركة هيرا ميدل إيست
Heera Middle East Company
Heera Middle East Company
0563657274 - 0547722446

شركة هيرا ميدل إيست
Heera Middle East Company
Heera Middle East Company
0563657274 - 0547722446

054 772 2446

www.heeramiddleeast.com

info@heeramiddleeast.com



شركة هيرا ميديل ايست
Heera Middle East Company

ROAD MARKING SIGNS

INSTALLATION

- ✓ • Surface cleaning and preparation prior to application
- ✓ • Applied by spray or screed machines on asphalt or concrete surfaces
- ✓ • Reflective glass beads applied during installation

IMPORTANCE & ADVANTAGES:

- ✓ • Improves traffic guidance and parking organization
- ✓ • Enhances visibility day and night
- ✓ • Durable, skid-resistant, and low maintenance



054 772 2446



www.heeramiddleeast.com

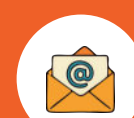

info@heeramiddleeast.com

0563657274 - 0547722446

0563657274 - 0547722446

0563657274 - 0547722446

CONCRETE

شركة هيرا ميدل إيست
Heera Middle East Company

شركة هيرا ميدل إيست
Heera Middle East Company

شركة هيرا ميدل إيست
Heera Middle East Company

CURBSTONES

- **CONCRETE CURBSTONES ARE PRECAST ELEMENTS USED TO DEFINE ROAD EDGES, SEPARATE SIDEWALKS, AND ORGANIZE TRAFFIC FLOW IN URBAN AND LANDSCAPE AREAS**

MATERIALS:

- **PRECAST HIGH-STRENGTH CONCRETE**
- **OPTIONAL REINFORCED STEEL (AS REQUIRED)**
- **SMOOTH OR TEXTURED SURFACE FINISH**

TECHNICAL SPECIFICATIONS

- **COMPRESSIVE STRENGTH: ≥ 30 MPA**
- **STANDARD LENGTH: 500-1000 MM**
- **HEIGHT: 250-300 MM**
- **WIDTH: 120-180 MM**
- **INSTALLED ON CONCRETE BEDDING WITH PROPER ALIGNMENT**
- **WEATHER-RESISTANT AND HEAVY-DUTY PERFORMANCE**



شركة هيرا ميدل إيست
Heera Middle East Company

شركة هيرا ميدل إيست
Heera Middle East Company

شركة هيرا ميدل إيست
Heera Middle East Company

0563657274 - 0547722446

0563657274 - 0547722446

0563657274 - 0547722446



054 772 2446



www.heeramiddleeast.com



info@heeramiddleeast.com

INTERLOCK TILES

- **INTERLOCKING CONCRETE PAVERS ARE DURABLE PAVING UNITS USED FOR SIDEWALKS, PARKING AREAS, DRIVEWAYS, AND LANDSCAPE PROJECTS.**

Technical Data Sheet

Interlocking Paving Unit (Rectangular 198*98*60/80 mm)

Product No. REC- 000

*Dimension:

Length: 200 mm
Width: 100 mm
Height: 60/80 mm

*Density:

2 to 2.3 gram per cubic centimeter

*Weight:

6cm (2.2-2.5 Kg) & 8 cm (3-4 kg)

*Compressive:

min 55 Mpa

*Absorption:

Max 5 %

*Abrasion Resistance:

Max 3 mm

*Mix Design:

Main Mix	Face Mix
Aggregate 3/8 (4.75 - 9.5) mm	Fine Sand 0 - 1.18
Aggregate 3/16 (2.36 - 4.75) mm	Portland Cements (OPC)
Coarse Sand (0.3 - 4.75) mm	Pigment
Pigment	W/C 0.4
Portland Cements (OPC)	
W/C 0.4	

*Process :

* We use the best technology present at the market (German technology with Compression nearly 20 ton) which gives homogenous mix and high quality products

* Curing Time : Minmum 24 Hours

* Curing System: Closed Chambers With Ventilation System full automatic

* Productivity : 9000 m2 Daily.

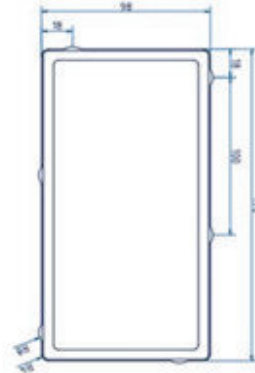

MATERIALS:

- **VIBRO-PRESSED CONCRETE**
- **HIGH-STRENGTH COLORED CONCRETE LAYER (OPTIONAL)**

TECHNICAL SPECIFICATIONS

- **COMPRESSIVE STRENGTH: $\geq 35-40$ MPA**
- **THICKNESS: 60 MM (LIGHT TRAFFIC) / 80 MM (HEAVY TRAFFIC)**
- **STANDARD SHAPES: RECTANGULAR, ZIGZAG, I-SHAPE, ETC.**
- **INSTALLED OVER SAND BEDDING WITH COMPACTED BASE**
- **HIGH LOAD RESISTANCE AND EASY MAINTENANCE**

شركة هيرا ميديل إيست
Heera Middle East Company
0563657274 - 0547722446

شركة هيرا ميديل إيست
Heera Middle East Company
0563657274 - 0547722446

شركة هيرا ميديل إيست
Heera Middle East Company
0563657274 - 0547722446

054 772 2446

www.heeramiddleeast.com

info@heeramiddleeast.com

CONCRETE

(CAR STOPPERS)

شركة هيرا ميدل إيست
Heera Middle East Company

شركة هيرا ميدل إيست
Heera Middle East Company

شركة هيرا ميدل إيست
Heera Middle East Company East Company
0563657274 - 0547722446

- **CONCRETE WHEEL STOPPERS ARE USED TO ORGANIZE VEHICLE PARKING AND PREVENT COLLISIONS WITH STRUCTURES.**

MATERIALS:

- **HIGH-STRENGTH PRECAST CONCRETE**
- **REINFORCED WITH STEEL BARS (IF REQUIRED)**
- **HIGH-VISIBILITY REFLECTIVE PAINT OR INSERTS (OPTIONAL)**

TECHNICAL SPECIFICATIONS

- **COMPRESSIVE STRENGTH: NOT LESS THAN 30 MPA**
- **STANDARD LENGTH: 500-1800 MM (AS REQUIRED)**
- **WIDTH: 120-150 MM**
- **HEIGHT: 100-150 MM**
- **SURFACE FINISH: SMOOTH OR ANTI-SLIP**
- **FIXING: ANCHOR BOLTS OR EMBEDDED INSTALLATION**



شركة هيرا ميدل إيست
Heera Middle East Company

شركة هيرا ميدل إيست
Heera Middle East Company

شركة هيرا ميدل إيست
Heera Middle East Company

LANDSCAPE

WORKS

شركة هيرا ميديل إيست
Heera Middle East Company
0563657274 - 0547722446

شركة هيرا ميديل إيست
Heera Middle East Company
0563657274 - 0547722446

- **LANDSCAPE WORKS INCLUDE THE DESIGN AND EXECUTION OF OUTDOOR SPACES TO ENHANCE AESTHETICS, FUNCTIONALITY, AND ENVIRONMENTAL QUALITY IN RESIDENTIAL, COMMERCIAL, AND PUBLIC PROJECTS**

MATERIALS:

- **NATURAL GRASS AND ARTIFICIAL TURF**
- **TREES, SHRUBS, AND SEASONAL PLANTS**
- **IRRIGATION SYSTEMS (PVC/HDPE PIPES, DRIP & SPRINKLER SYSTEMS)**
- **NATURAL STONE, INTERLOCK, AND DECORATIVE CONCRETE**
- **STEEL, WOOD, OR WPC ELEMENTS (PERGOLAS, BENCHES, FENCES)**

MAIN TYPES OF LANDSCAPE WORKS:

- **SOFTSCAPE: NATURAL GRASS, PLANTS, TREES, SOIL PREPARATION, IRRIGATION SYSTEMS**
- **HARDSCAPE: INTERLOCK PAVING, CURBSTONES, CONCRETE WORKS, WALKWAYS, RETAINING WALLS**
- **LIGHTING: GARDEN LIGHTING, PATHWAY LIGHTS, POLE LIGHTS**
- **WATER FEATURES: FOUNTAINS, WATERFALLS, DECORATIVE PONDS**
- **OUTDOOR FURNITURE & STRUCTURES: PERGOLAS, SEATING AREAS, SHADING SYSTEMS**



شركة هيرا ميديل إيست
Heera Middle East Company
0563657274 - 0547722446

شركة هيرا ميديل إيست
Heera Middle East Company
0563657274 - 0547722446

شركة هيرا ميديل إيست
Heera Middle East Company
0563657274 - 0547722446

054 772 2446

www.heeramiddleeast.com

info@heeramiddleeast.com



Specialized Works for Fuel Stations

Asphalt Works

Heavy-duty asphalt paving for station yards and access roads, designed to withstand fuel spills and heavy traffic loads.

Road & Area Marking

High-visibility traffic markings for lanes, parking, and circulation paths to ensure safe and organized vehicle movement.

Epoxy Flooring

Fuel- and chemical-resistant epoxy flooring systems for service areas, shops, and technical rooms.

شركة هيرا ميديا إيست
Heera Middle East Company
0563657274 - 0547722446

شركة هيرا ميديا إيست
Heera Middle East Company
0563657274 - 0547722446

شركة هيرا ميديا إيست
Heera Middle East Company
0563657274 - 0547722446

Heera Middle East Company



🎯 Epoxy Floor Marking

Durable epoxy-based markings for pedestrian paths, safety zones, and operational areas inside the station.

⚠️ Safety & Accessories

Supply and installation of car stoppers, speed humps, bollards, corner guards, mirrors, and directional & warning signs.

✅ Key Benefits

- Enhanced safety and traffic control
- High durability and chemical resistance
- Compliance with operational requirements of fuel stations
- Clean, organized, and efficient station layout

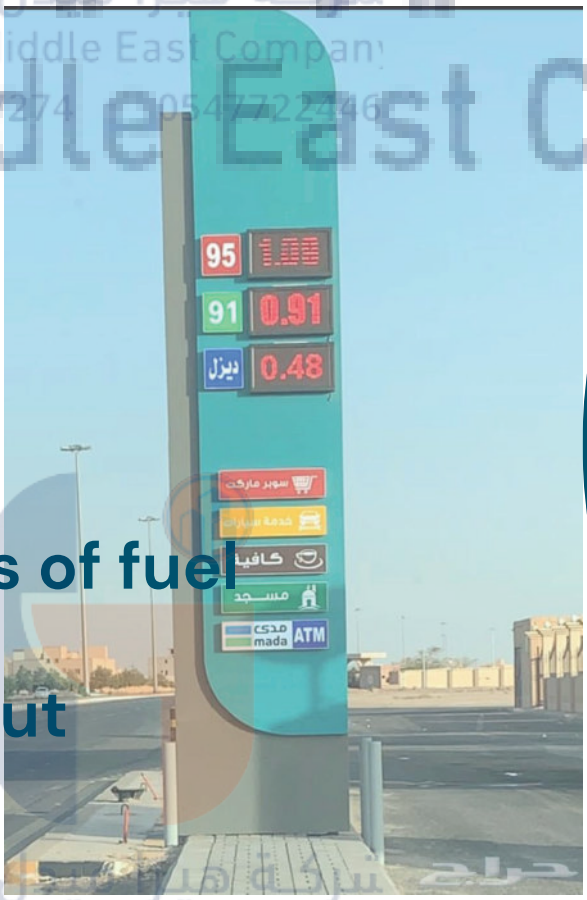

شركة هيرا ميديل ايست
Heera Middle East Company
0563657274 - 0547722446

شركة هيرا ميديل ايست
Heera Middle East Company
0563657274 - 0547722446

شركة هيرا ميديل ايست
Heera Middle East Company
0563657274 - 0547722446

📞 054 772 2446

🌐 www.heeramiddleeast.com

✉️ info@heeramiddleeast.com



شركة هيرا ميديا إيست
Heera Middle East Company
0563657274 - 0547722446



شركة هيرا ميديا إيست
Heera Middle East Company
0563657274 - 0547722446

METAL WORK

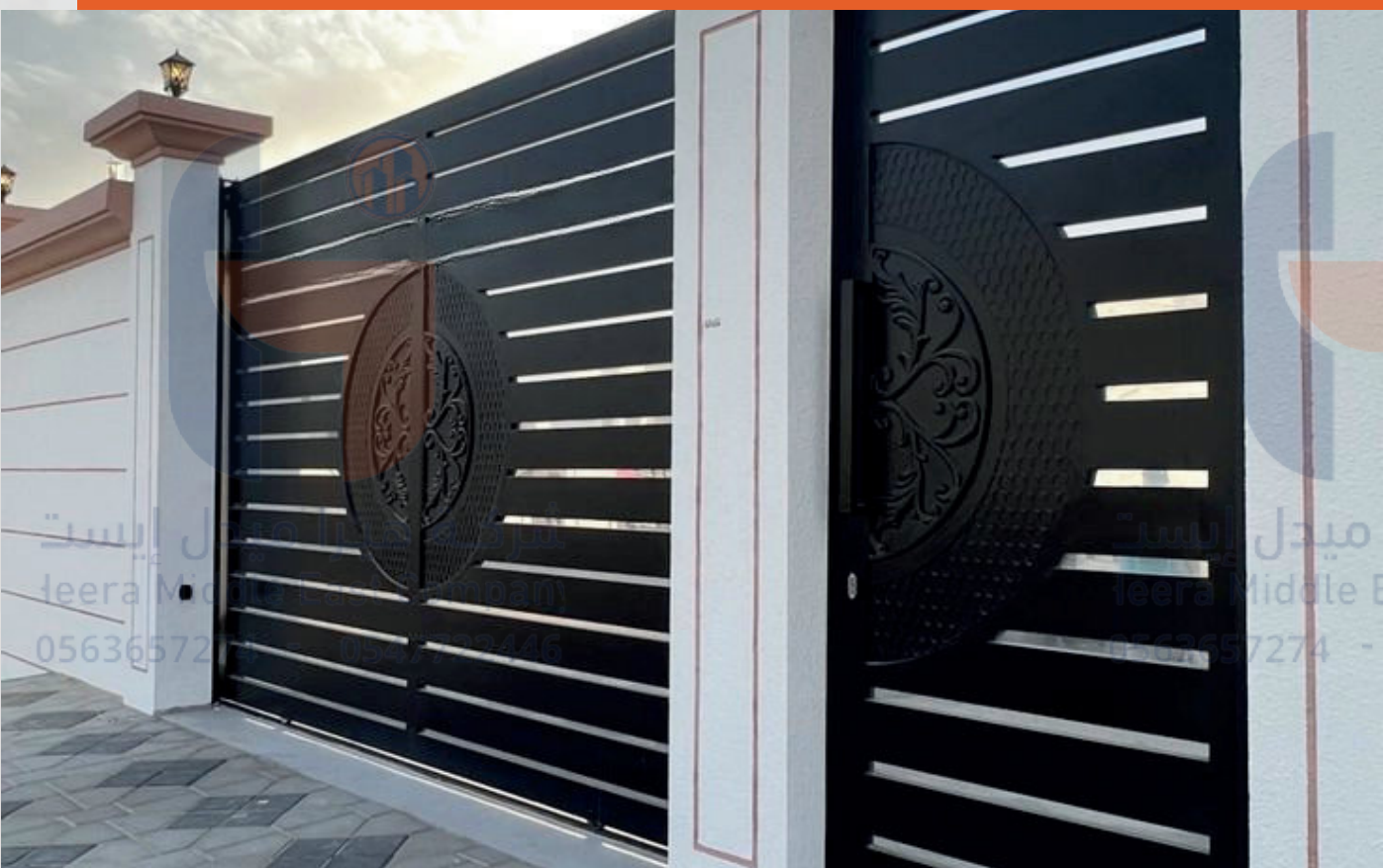

شركة هيرا ميديا إيست
Heera Middle East Company
0563657274 - 0547722446



HANDRIL FOR PROTECT COLUMN FROM DAMADGE

SPECIALISTS IN IRONWORK, STAINLESS STEEL, AND CRYSTAL DOORS AND WINDOWS

شركة هيرا ميديا إيست
Heera Middle East Company
0563657274 - 0547722446

Our works

- STEEL STAIRS
- STEEL HANDRIL
- STANLISS STEEL HANDRIL
- STEEL FENCE



شركة هيرا ميديا إيست
Heera Middle East Company
0563657274 - 0547722446

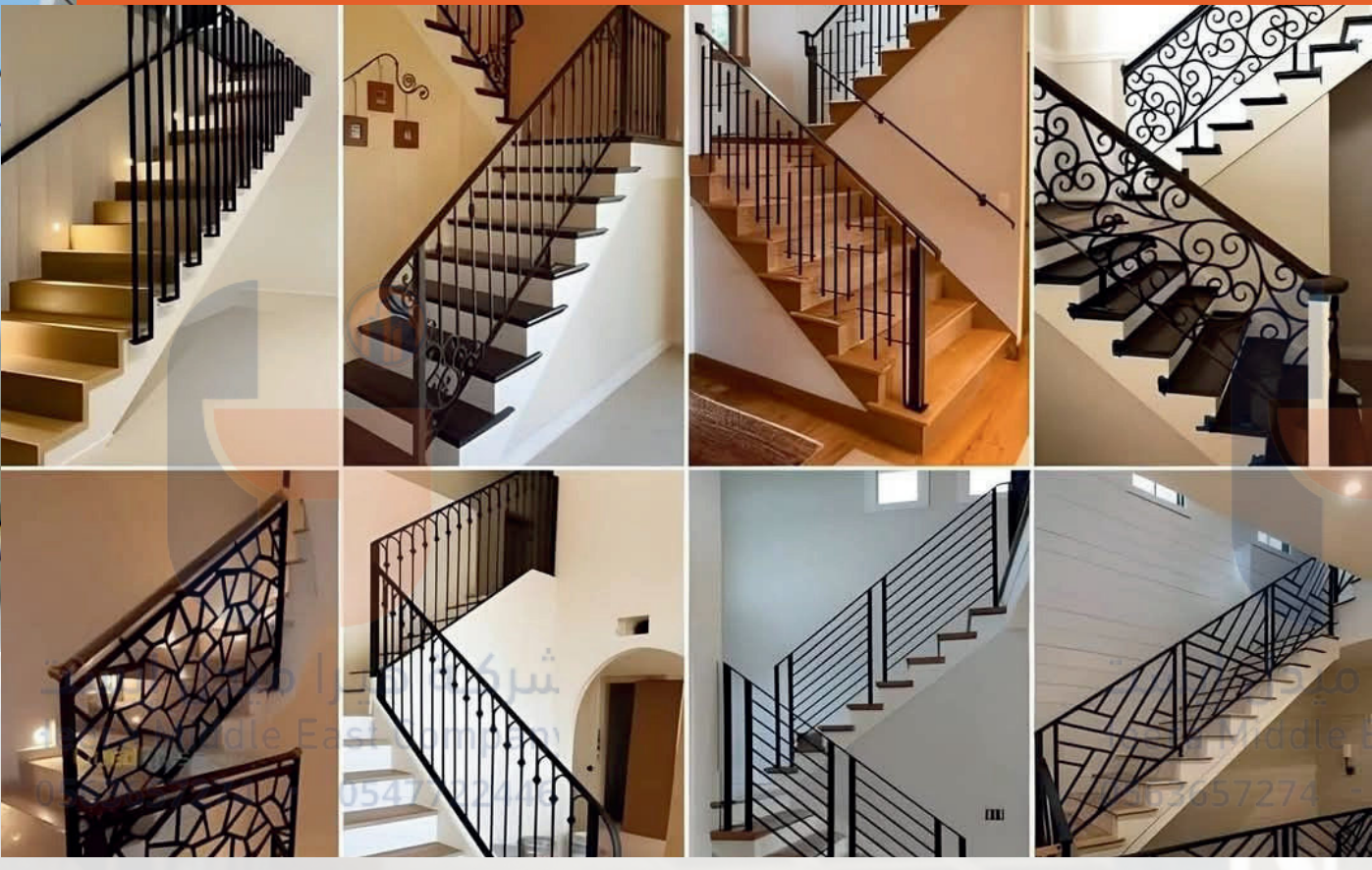

METAL WORK

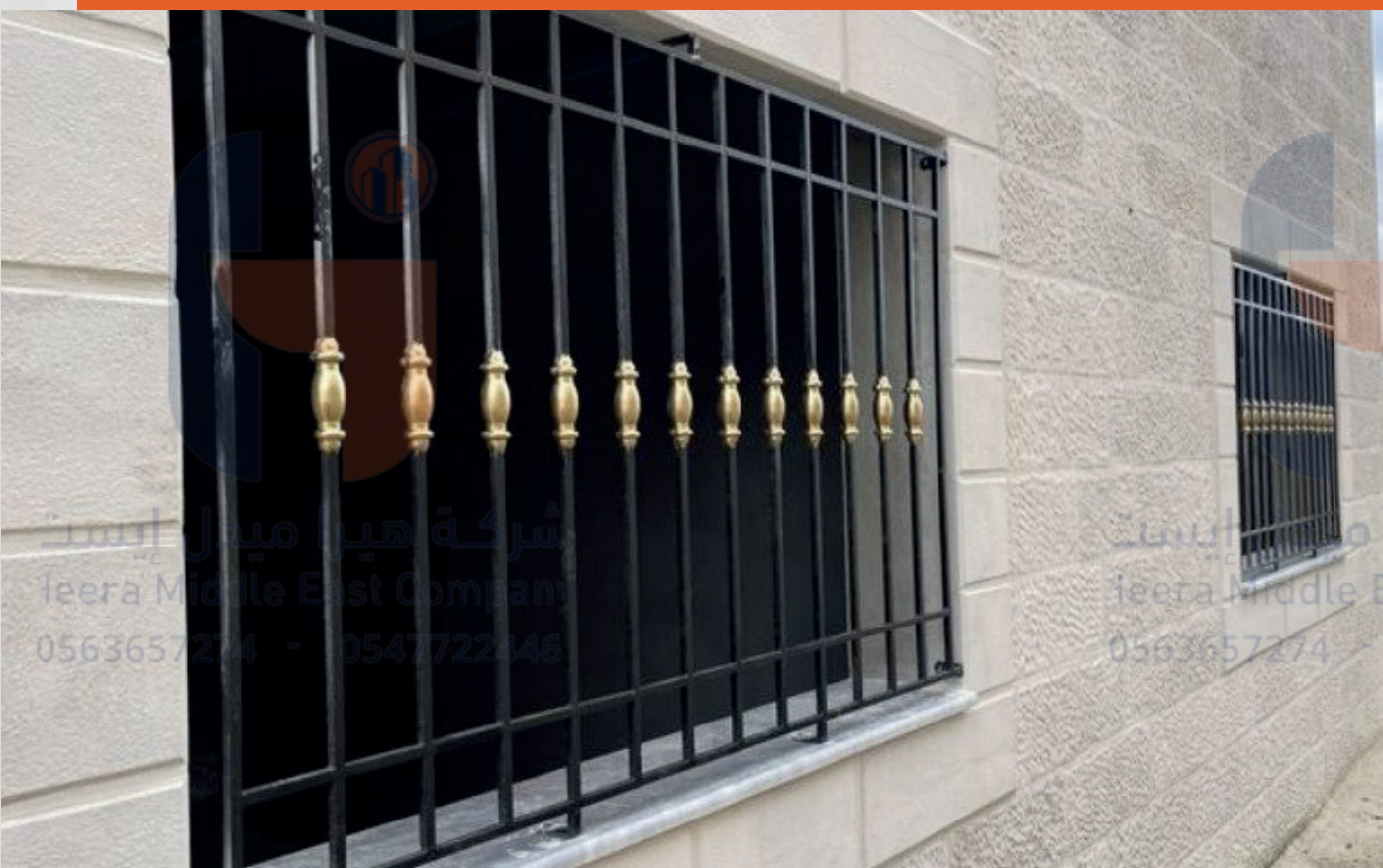

WE PROVIDE COMPREHENSIVE METAL FABRICATION AND STEEL FORMING SERVICES IN ACCORDANCE WITH HIGH QUALITY STANDARDS. OUR SCOPE INCLUDES THE MANUFACTURING OF STEEL DOORS, WINDOWS, AND HANDRAILS IN VARIOUS DESIGNS AND SIZES TO SUIT RESIDENTIAL, COMMERCIAL, AND INDUSTRIAL PROJECTS

Key Features

- DESIGN AND FABRICATION AS PER DRAWINGS AND TECHNICAL SPECIFICATIONS
- HIGH-QUALITY STEEL MATERIALS FOR STRENGTH AND DURABILITY
- PROFESSIONAL CUTTING, BENDING, WELDING, AND FINISHING PROCESSES
- ANTI-CORROSION PROTECTION USING EPOXY OR OVEN-BAKED COATINGS
- MODERN AND CLASSIC DESIGN OPTIONS

ALUMINUM WORKS

Aluminum works include the supply, fabrication, and installation of aluminum profiles and systems used in façades, windows, doors, partitions, and architectural cladding, in accordance with approved drawings and specifications.

TYPES OF ALUMINUM PROFILES

- ✓ • Standard aluminum profiles
- ✓ • Thermal break aluminum profiles
- ✓ • Curtain wall systems
- ✓ • Shopfront systems
- ✓ • Aluminum louvers and ventilation profiles

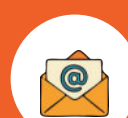

ELEMENTS

SCOPE OF WORKS

- ✓ • Aluminum windows and doors
- ✓ • Glass and aluminum façades
- ✓ • Internal aluminum and glass partitions
- ✓ • Aluminum handrails and balustrades
- ✓ • Aluminum cladding and architectural features

TYPES OF ALUMINUM PROFILES

- ✓ • Standard aluminum profiles
- ✓ • Thermal break aluminum profiles
- ✓ • Curtain wall systems
- ✓ • Shopfront systems
- ✓ • Aluminum louvers and ventilation profiles

شركة هيرا ميديل إيست
Heera Middle East Company

شركة هيرا ميديل إيست
Heera Middle East Company
0563657274 - 0547722446

شركة هيرا ميديل إيست
Heera Middle East Company
0563657274 - 0547722446

شركة هيرا ميديل إيست
Heera Middle East Company
0563657274 - 0547722446

054 772 2446

www.heeramiddleeast.com

info@heeramiddleeast.com



GRC Facade Systems

(Glassfiber Reinforced Concrete)

Description

GRC facade systems are architectural cladding elements used for building facades, offering high design flexibility and the appearance of natural concrete or stone with reduced weight.

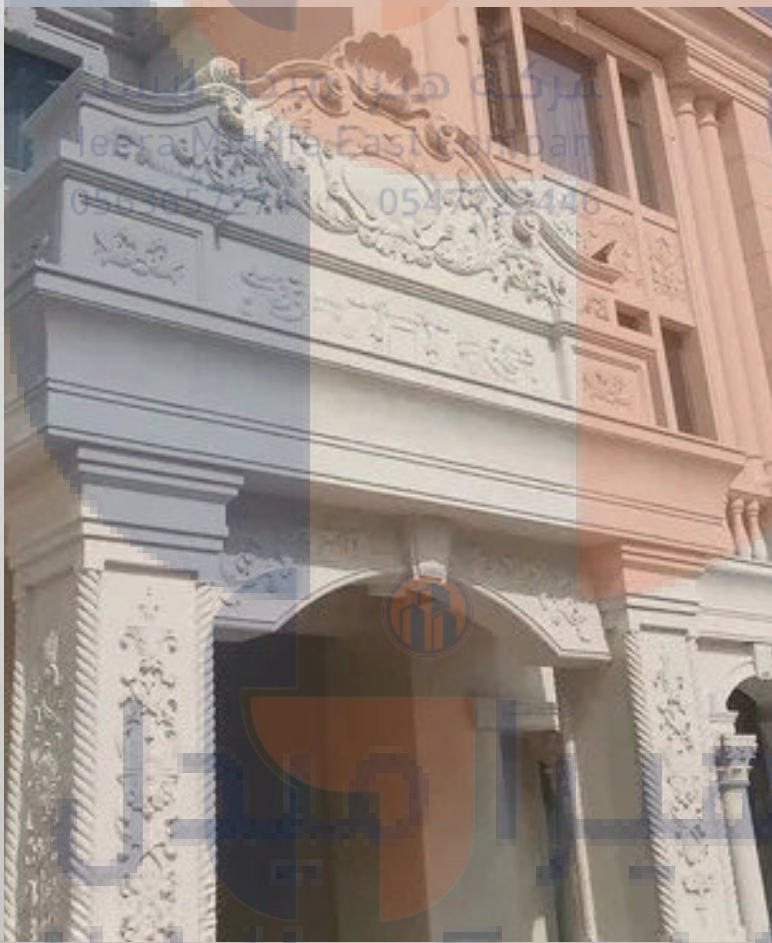

Materials

Cement-based mix reinforced with glass fibers

Factory-molded panels with various textures and finishes

Importance & Advantages:

- Lightweight compared to traditional concrete
- High durability and weather resistance
- Excellent design flexibility and architectural detailing
- Suitable for complex facade shapes



054 772 2446



www.heeramiddleeast.com

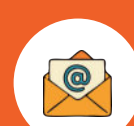

info@heeramiddleeast.com



GRP Facade Systems

(Glassfiber Reinforced Plastic)

Description

GRP facade systems are lightweight composite cladding panels used for building facades, providing high strength, flexibility, and modern architectural finishes.



Materials

- Polyester or epoxy resin reinforced with glass fibers
- Factory-finished panels with smooth or textured surfaces

Importance & Advantages:

- Very lightweight with high strength-to-weight ratio
- Excellent resistance to corrosion and weather conditions
- Easy installation and reduced structural load
- Suitable for modern and customized facade designs



054 772 2446



www.heeramiddleeast.com



info@heeramiddleeast.com



PRECAST CONCRETE SYSTEMS

GENERAL DESCRIPTION

- Precast concrete consists of structural and architectural concrete elements manufactured in specialized factories under controlled conditions, then transported and installed on site. This system is widely used in buildings and infrastructure projects to ensure high quality, durability, and fast construction.

TYPICAL PRECAST CONCRETE ELEMENTS

- Columns and beams
- Precast slabs and floor systems
- Load-bearing and non-load-bearing walls
- Staircases and landings
- Prestressed and post-tensioned elements
- Facade panels and boundary walls
- Manholes, utility chambers, and infrastructure elements



PRECAST CONCRETE SYSTEMS

MATERIALS

- High-strength concrete complying with SBC 304 – Concrete Structures Code
- Reinforcing steel or prestressing tendons as per approved structural design
- Approved concrete admixtures to improve workability and durability
- Embedded plates, anchors, and connection accessories

MANUFACTURING & QUALITY CONTROL

- Casting in approved steel or wooden molds
- Proper curing methods to achieve specified concrete strength
- Mandatory testing of concrete strength and quality as per SBC
- Factory quality control and documentation

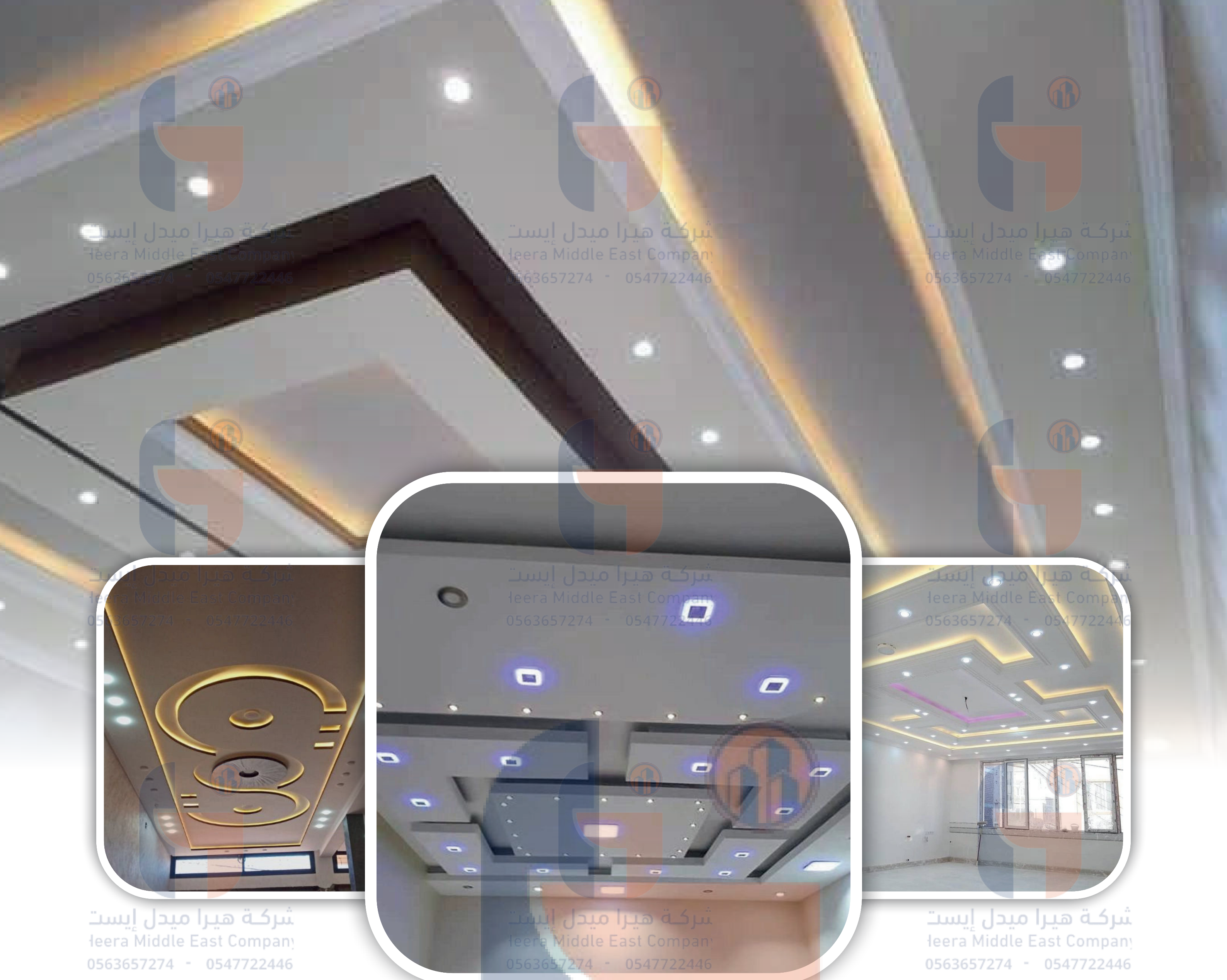

GYPSUM BOARD

Description

Gypsum board is a modern finishing system consisting of gypsum panels fixed on a galvanized metal framework. It is widely used for suspended ceilings and internal partitions due to its light weight, fast installation, and clean aesthetic finish

Types of Gypsum Boards

- *Standard Gypsum Board: For general interior dry areas.
- *Moisture-Resistant Board: For kitchens, bathrooms, and humid areas.
- *Fire-Resistant Board: For areas requiring fire protection.
- *Moisture & Fire-Resistant Board: For sensitive areas such as hospitals and commercial kitchens



شركة هيرا ميديل ايسنت
Heera Middle East Company
0563657274 - 0547722446



شركة هيرا ميديل ايسنت
Heera Middle East Company
0563657274 - 0547722446



شركة هيرا ميديل ايسنت
Heera Middle East Company
0563657274 - 0547722446



شركة هيرا ميديل ايسنت
Heera Middle East Company
0563657274 - 0547722446



شركة هيرا ميديل ايسنت
Heera Middle East Company
0563657274 - 0547722446



شركة هيرا ميديل ايسنت
Heera Middle East Company
0563657274 - 0547722446



شركة هيرا ميديل ايسنت
Heera Middle East Company
0563657274 - 0547722446

شركة هيرا ميديل ايسنت
Heera Middle East Company
0563657274 - 0547722446

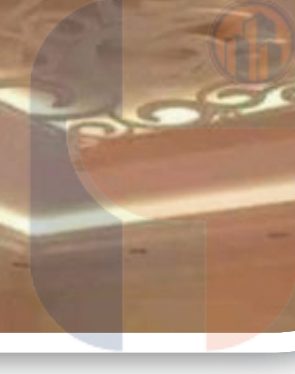

شركة هيرا ميديل ايسنت
Heera Middle East Company
0563657274 - 0547722446

GYPSUM BOARD

Advantages

- Fast and easy installation.
- Lightweight, reducing structural load.
- Good acoustic and thermal insulation.
- Flexible for various architectural and decorative designs

Main Components & Details

- Galvanized metal framework (U-Tracks and C-Studs).
- Gypsum boards with different thicknesses (9.5 - 12.5 - 15 mm).
- Joint tape and finishing compound.
- Optional thermal or acoustic insulation.
- Final paint or decorative finish as per design.

شركة هيرا ميديل ايسنت
Heera Middle East Company
0563657274 - 0547722446

شركة هيرا ميديل ايسنت
Heera Middle East Company
0563657274 - 0547722446

شركة هيرا ميديل ايسنت
Heera Middle East Company
0563657274 - 0547722446



054 772 2446



www.heeramiddleeast.com



info@heeramiddleeast.com

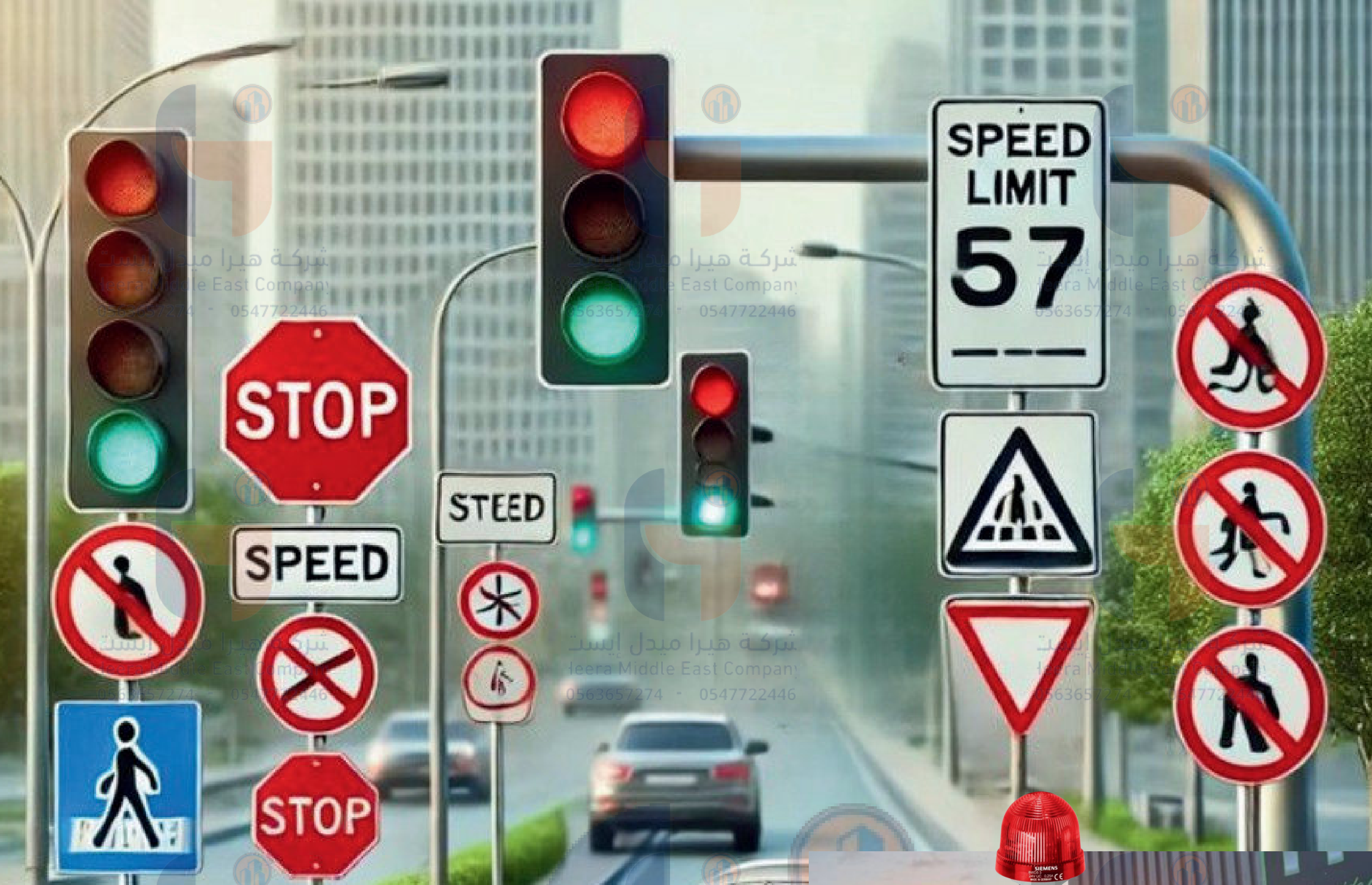

ROAD SIGNS, CONCRETE BARRIERS, AND NEW JERSEY



Road signs, concrete barriers, and New Jersey barriers are essential elements of traffic safety systems, used to regulate traffic flow, guide drivers, and enhance road safety.

Road signs include warning, regulatory, and directional signs made from high-visibility reflective materials, while concrete and New Jersey barriers are used to separate lanes, protect work zones, and reduce the severity of accidents.

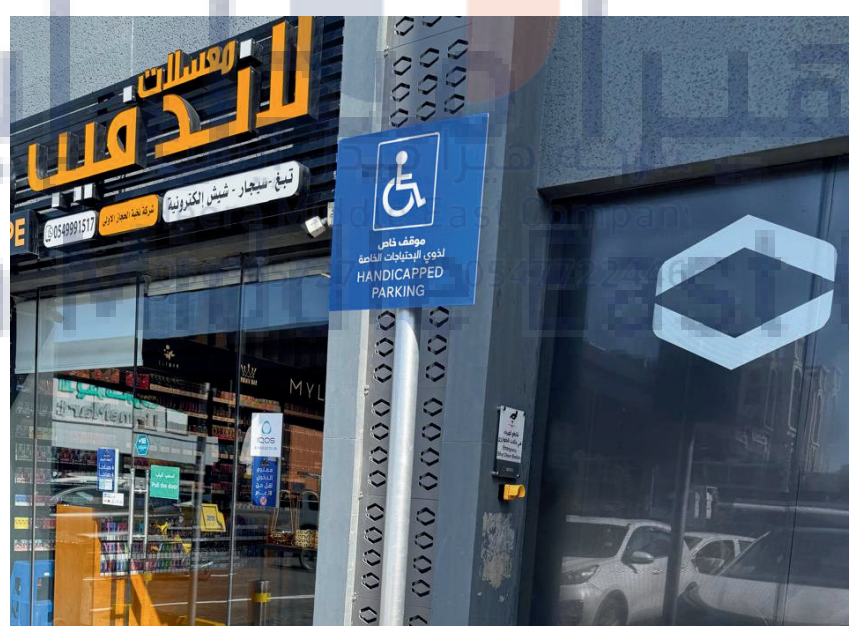

ROAD SIGNS

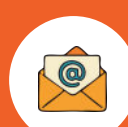



SAFETY TOOLS FOR ROADS

Road safety tools are essential elements used to enhance traffic control, protect road users, and reduce accidents.

These tools are designed to improve visibility, guide vehicles, and provide clear warnings in both temporary and permanent road conditions.

شركة هيرا ميديل إيست
Heera Middle East Company
0563657274 - 0547722446

شركة هيرا ميديل إيست
Heera Middle East Company
0563657274 - 0547722446

شركة هيرا ميديل إيست
Heera Middle East Company
0563657274 - 0547722446



054 772 2446



www.heeramiddleeast.com



info@heeramiddleeast.com



UNIPARK



Unipark is an automatic parking space protection system manufactured by CAME Italy, designed to secure and reserve individual parking spaces through remote-controlled operation. Built with a durable galvanized steel structure and advanced safety electronics, it provides a reliable and efficient solution for residential and commercial projects

AUTOMATIC BARRIER GATE

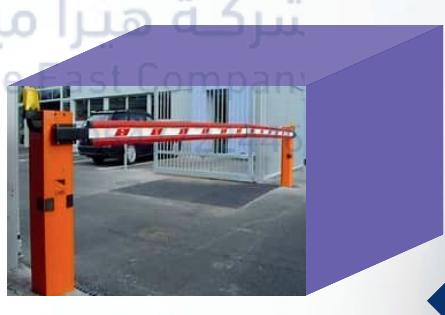

The Automatic Barrier Gate with DC Brushless Motor is a high-performance access control solution operating on 24V DC power. Featuring adjustable opening speed, obstacle detection sensor, and durable steel housing, it provides secure and efficient vehicle management for various residential and commercial applications





TYRE KILLERS / SPIKE ROAD BLOCKERS



Tyre Killers (Spike Road Blockers) are high-security vehicle access control systems designed to prevent unauthorized or wrong-way entry. The system features heavy-duty steel spikes that allow vehicles to pass in one direction while puncturing tires if crossed in the opposite direction.

Built for durability and reliability, they can be installed as fixed or hydraulic models and integrated with barrier gates and access control systems



HYDRAULIC ROAD BLOCKERS



Hydraulic Road Blockers are high-security vehicle access control systems designed to prevent unauthorized or forced vehicle entry. The system operates by means a powerful hydraulic mechanism that raises a heavy-duty steel barrier or wedge from ground level to physically block vehicles. Engineered for maximum impact resistance, hydraulic road blockers are widely used in high-security environments requiring strong perimeter protection



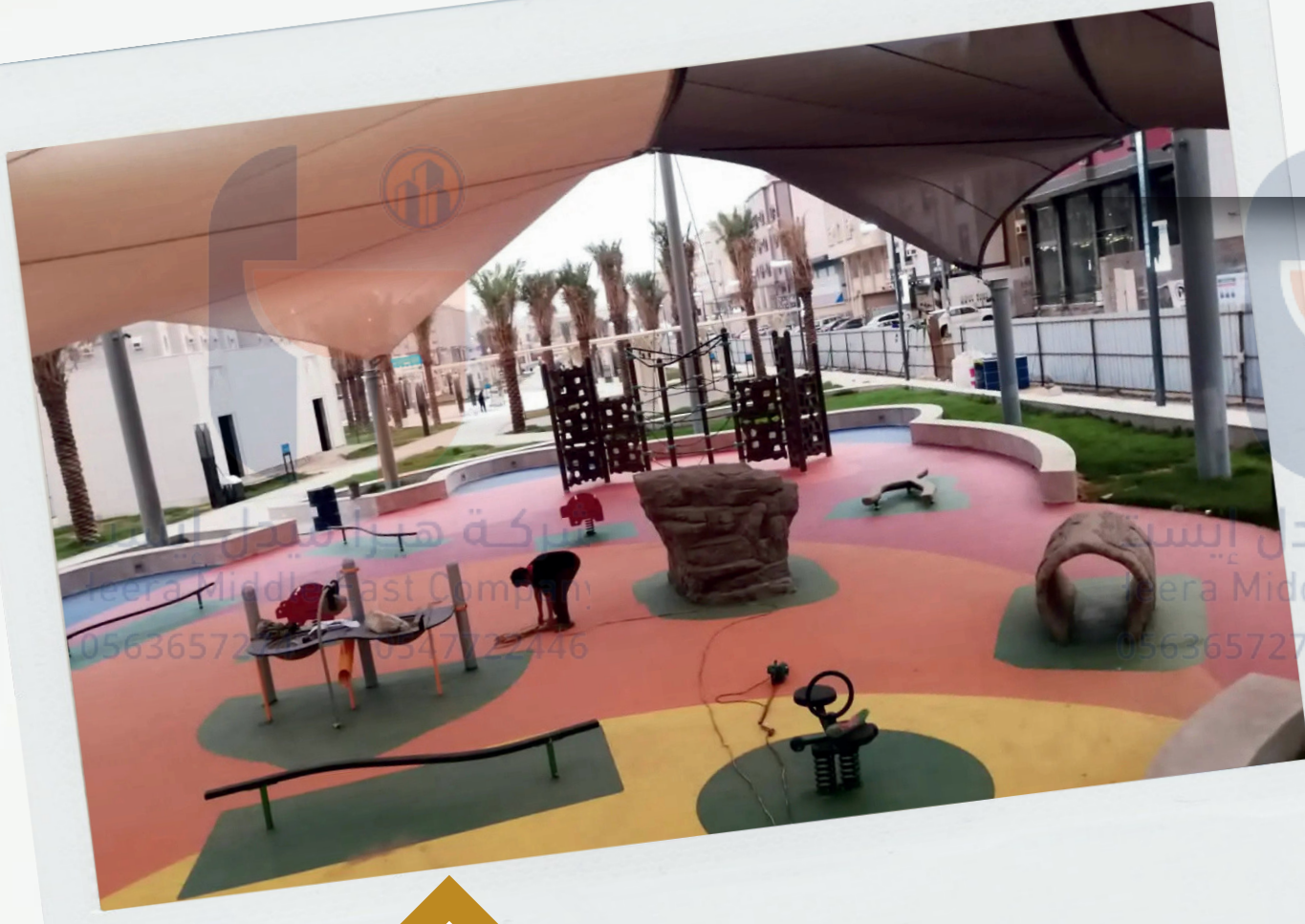

EPDM RUBBER FLOORING PLAYGROUNDS & PUBLIC AREAS

OVERVIEW:

- EPDM (Ethylene Propylene Diene Monomer) rubber flooring is a safe, durable, and weather-resistant surface widely used in children's playgrounds and public areas. It is designed to provide impact absorption, reduce injuries from falls, and create colorful, attractive outdoor environments.

MATERIALS:

- EPDM rubber granules (colored, UV-resistant)
- SBR rubber base layer (optional for shock absorption)
- Polyurethane (PU) binder

TYPICAL THICKNESS:

- Playgrounds: 20-50 mm (depending on fall height requirements)
- Public walkways: 10-20 mm



054 772 2446



www.heeramiddleeast.com

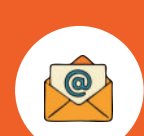

info@heeramiddleeast.com



RUBBER & ACRYLIC SPORTS FLOORING

1. RUBBER SPORTS FLOORING

- Rubber flooring is commonly used for indoor and outdoor sports areas due to its flexibility, durability, and shock-absorbing properties.
- SBR or EPDM rubber granules
- PU binder
- Gym areas: 8–15 mm
- Multi-purpose courts: 10–20 mm

2. ACRYLIC SPORTS FLOORING

Acrylic sports flooring is a high-performance coating system commonly used for outdoor courts. It provides a smooth, slip-resistant, and durable playing surface.

- Acrylic resin coatings
- Silica sand (for texture and slip resistance)
- Line marking paint
- 2–5 mm (multi-layer coating system)



STRUCTURAL JOINTS TREATMENT WORKS

Aluminum structural joint cover system designed to protect and cover expansion and construction joints in floors, walls, and ceilings. The system allows structural movement while maintaining a safe, durable, and aesthetic surface

Materials

- Cover plate: Extruded aluminum profile
- Fixing system: Stainless steel spring clips
- Finish: Natural aluminum (mill finish) or powder-coated (optional)
- Fasteners: Stainless steel anchors (as required)

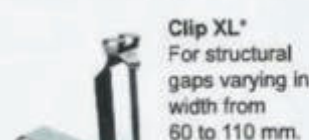
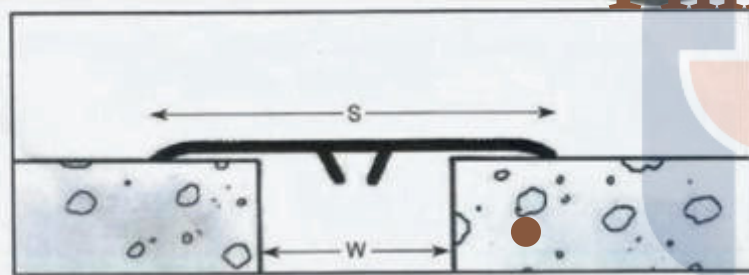
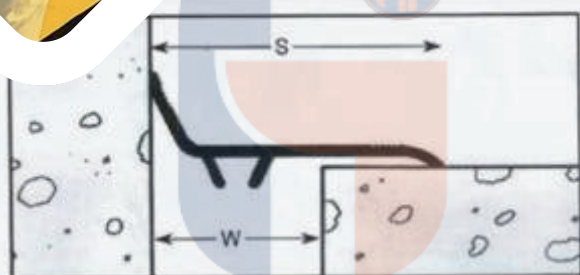

054 772 2446



www.heeramiddleeast.com



info@heeramiddleeast.com

Structural Joint Cover System

Materials

- Extruded aluminum cover plate
- Stainless steel spring clips
- Optional powder-coated finish
- Stainless steel fixing accessories

Standard Sizes

- Joint width: 15 – 80 mm
- Cover width: 40 – 170 mm
- Minimum joint depth: 40 – 70 mm
- Standard length: 3.0 m per piece

Installation

- Clean and prepare the joint opening
- Fix stainless steel spring clips inside the joint
- Snap the aluminum cover into the clips
- Ensure proper alignment and secure fit

Applications

- Expansion and construction joints
- Floors, walls, and ceilings
- Parking areas and commercial buildings
- Public and industrial facilities

Model	Joint Width (mm)	Cover Width (mm)	Min. Joint Depth (mm)
LG 250/50	15-35	50	40
LGF 250/50	15-35	40	40
LG 250/70	15-35	70	40
LGF 250/70	15-35	50	40
LG 250/100	15-35	100	40
LGF 250/100	35-60	75	70
LG 250/150	35-80	150	70
LG 250/170	35-80	170	70



شركة هيرا ميدل إيست
Heera Middle East Company

0563657274 - 0547722446

- Security Systems
- Surveillance Cameras
- Smart Solutions



SMART SYSTEM & SURVEILLANCE CAMERAS SOLUTIONS



Smart Systems & Surveillance Cameras Solutions

We specialize in providing advanced **smart systems** and high-performance **surveillance camera solutions** tailored to meet both residential and commercial security needs.

SMART SYSTEMS

- Home automation systems
- Building automation
- Access control systems
- Smart intercoms
- Smart security alarms
- Network infrastructure integration

SURVEILLANCE CAMERAS

- CCTV cameras
- IP cameras
- PTZ cameras
- Explosive-proof cameras
- Thermal cameras
- Video analytics systems



HIKVISION Dome Camera Datsheet

DS-CD91321G0-I



hikvision Network IR Bullet Camera Datsheet

IPC-F1W8004ZE-SE



AXIS AXIS 44 SM Ultra Compact Mini Dome





شركة هيرا ميدل إيست
Heera Middle East Company
Heera Middle East Company
0563657274 - 0547722446

- Electrical Installations
- Plumbing Solutions
- Maintenance & Repair

ELECTRICAL & PLUMBING SERVICES



ELECTRICAL SERVICES

- Custom electrical installations
- Panel upgrades
- Lighting systems
- Safety inspections
- Wiring solutions
- Electrical troubleshooting

PLUMBING SERVICES

- Comprehensive plumbing installations
- Pipe repair and replacement
- Leak detection and repair
- Drain and sewer cleaning
- Water heater installation and repair



⚡ Electrical Services

- Custom electrical installations
- Switchboard and panel upgrades
- Lighting system design and setup
- Home and business rewiring
- Safety inspections and code compliance
- Electrical troubleshooting and repair
- Surge protection and backup power solutions

💧 Plumbing Services

- Comprehensive plumbing installations
- Pipe repair and replacement
- Leak detection and repair
- Drain and sewer cleaning
- Water heater installation and repair
- Fixture replacement and installation
- Plumbing inspection and maintenance





شركة هيرا ميديل إيست
Heera Middle East Company
0563657274 - 0547722446

شركة هيرا ميديل إيست
Heera Middle East Company
0563657274 - 0547722446

شركة هيرا ميديل إيست
Heera Middle East Company
0563657274 - 0547722446

شركة هيرا ميديل إيست
Heera Middle East Company
0563657274 - 0547722446

شركة هيرا ميديل إيست
Heera Middle East Company
0563657274 - 0547722446

شركة هيرا ميديل إيست
Heera Middle East Company
0563657274 - 0547722446



WALL CLADDING CHIPBOARD ALTERNATIVE

DESCRIPTION

Decorative wall cladding inspired by chipboard textures, used in modern and industrial-style interior designs.

MATERIALS

- MDF / HPL decorative panels
- Laminated or coated boards



شركة هيرا ميديل إيست
Heera Middle East Company
0563657274 - 0547722446

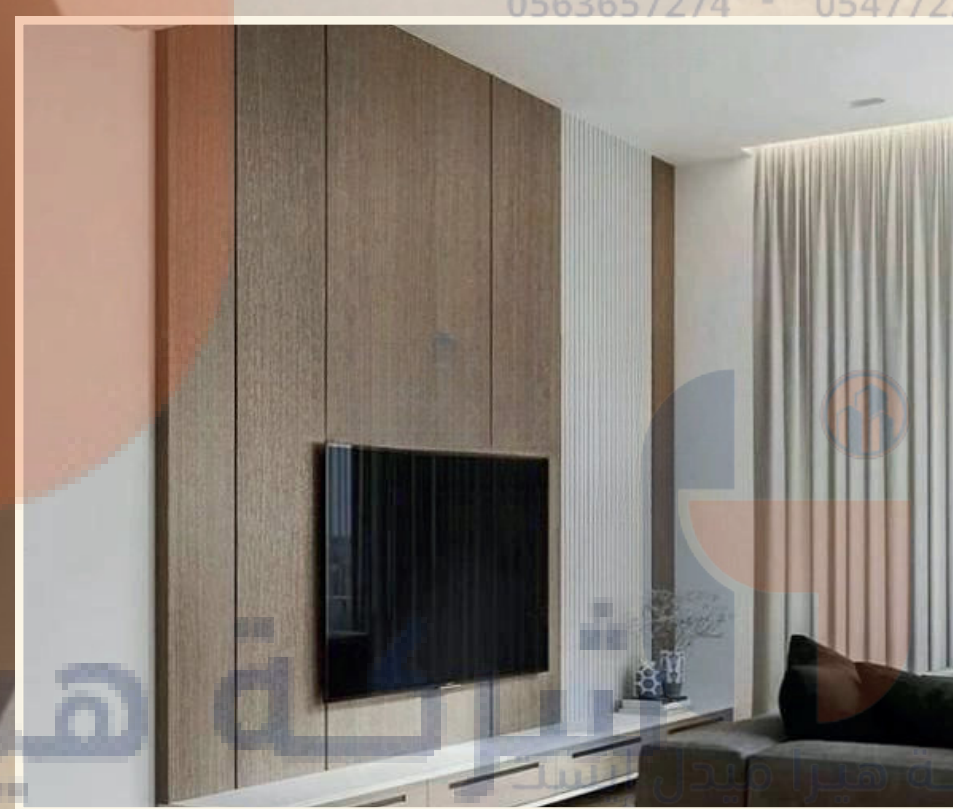

شركة هيرا ميديل إيست
Heera Middle East Company
0563657274 - 0547722446

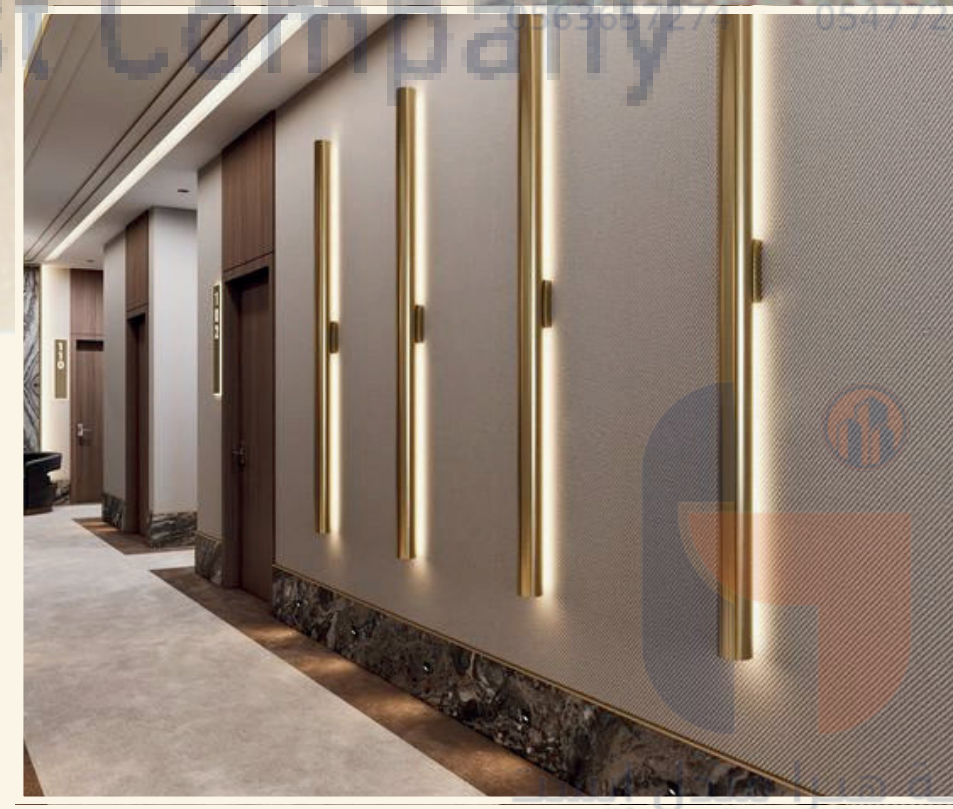

شركة هيرا ميديل إيست
Heera Middle East Company
0563657274 - 0547722446

IMPORTANCE & ADVANTAGES:

- Modern industrial aesthetic
- Cost-effective decorative solution
- Easy maintenance and quick installation



054 772 2446



www.heeramiddleeast.com

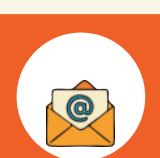

info@heeramiddleeast.com

شركة هيرا ميديل إيست
Heera Middle East Company
0563657274 - 0547722446

شركة هيرا ميديل إيست
Heera Middle East Company
0563657274 - 0547722446

شركة هيرا ميديل إيست
Heera Middle East Company
0563657274 - 0547722446

شركة هيرا ميديل إيست
Heera Middle East Company
0563657274 - 0547722446

شركة هيرا ميديل إيست
Heera Middle East Company
0563657274 - 0547722446

شركة هيرا ميديل إيست
Heera Middle East Company
0563657274 - 0547722446

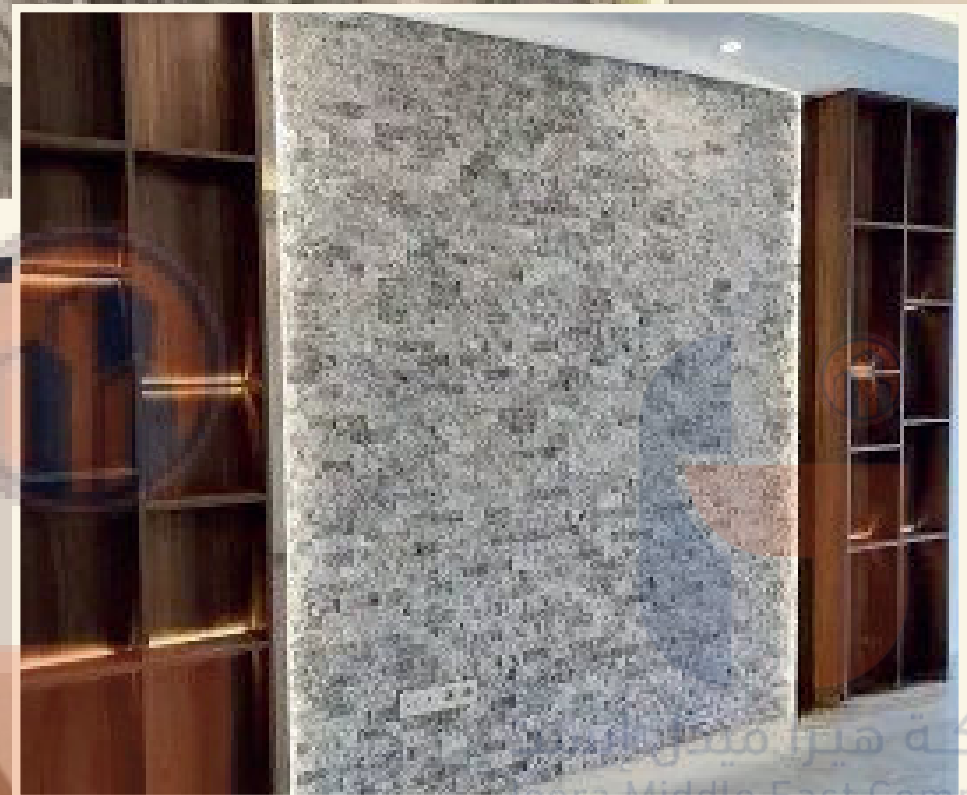

شركة هيرا ميديل إيست
Heera Middle East Company
0563657274 - 0547722446



شركة هيرا ميديل إيست
Heera Middle East Company
0563657274 - 0547722446



شركة هيرا ميديل إيست
Heera Middle East Company
0563657274 - 0547722446



شركة هيرا ميديل إيست
Heera Middle East Company

WALL CLADDING STONE ALTERNATIVE

DESCRIPTION

Decorative wall cladding panels designed to replicate the natural stone appearance, suitable for interior and exterior walls in residential, commercial, and hospitality projects.

MATERIALS

- PVC / PU stone panels
- Lightweight artificial stone or composite panels
- UV and moisture-resistant surface coating

IMPORTANCE & ADVANTAGES

- Natural stone appearance with lighter weight
- Easy and fast installation compared to natural stone
- Resistant to moisture, weather, and cracking
- Cost-effective with low maintenance requirements



054 772 2446



www.heeramiddleeast.com

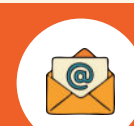

info@heeramiddleeast.com



WOOD ALTERNATIVE WALL PANELS

Description

Decorative wall cladding that simulates natural wood appearance, used for interior and exterior walls to achieve a warm and modern look.

Materials

- ▶ • PVC / WPC / HPL panels
- ▶ • UV and moisture resistant surface

IMPORTANCE & ADVANTAGES

- WOOD APPEARANCE WITHOUT MAINTENANCE ISSUES
- RESISTANT TO MOISTURE, TERMITES, AND WARPING
- EASY INSTALLATION AND LONG SERVICE LIFE



شركة هيرا ميديل إيست
Heera Middle East Company

شركة هيرا ميديل إيست
Heera Middle East Company
0563657274 - 0547722446



شركة هيرا ميديل إيست
Heera Middle East Company
0563657274 - 0547722446



شركة هيرا ميديل إيست
Heera Middle East Company
0563657274 - 0547722446



شركة هيرا ميديل إيست
Heera Middle East Company
0563657274 - 0547722446

IMPORTANCE & ADVANTAGES:-

- LUXURIOUS MARBLE LOOK AT LOWER COST
- LIGHTWEIGHT AND EASY TO INSTALL
- RESISTANT TO MOISTURE AND STAINS

MARBLE ALTERNATIVE WALL PANELS

Description

Wall cladding panels designed to replicate natural marble finishes, suitable for luxury interiors and commercial spaces.

Materials

- ▶ • PVC marble sheets
- ▶ • SPC or composite panels
- ▶ • Lightweight artificial stone

054 772 2446

www.heeramiddleeast.com

info@heeramiddleeast.com

شركة هيرا ميديل إيست
Heera Middle East Company
0563657274 - 0547722446

شركة هيرا ميديل إيست
Heera Middle East Company
0563657274 - 0547722446

شركة هيرا ميديل إيست
Heera Middle East Company
0563657274 - 0547722446



شركة هيرا ميديل إيست
Heera Middle East Company

شركة هيرا ميديل إيست
Heera Middle East Company
0563657274 - 0547722446

شركة هيرا ميديل إيست
Heera Middle East Company
0563657274 - 0547722446

شركة هيرا ميديل إيست
Heera Middle East Company
0563657274 - 0547722446

شركة هيرا ميديل إيست
Heera Middle East Company
0563657274 - 0547722446

شركة هيرا ميديل إيست
Heera Middle East Company
0563657274 - 0547722446



PARQUET FLOORING

We provide supply and installation services for various parquet flooring systems suitable for residential, commercial, and administrative projects, ensuring high quality standards and precise workmanship.

Types of Parquet Flooring

- ▶ • Solid Wood Parquet
- ▶ • Engineered Wood Flooring
- ▶ • Laminate Flooring
- ▶ • SPC Flooring (Stone Plastic Composite)

INSTALLATION METHODS

- CLICK SYSTEM INSTALLATION
- DIRECT GLUE-DOWN INSTALLATION
- FLOATING SYSTEM OVER FOAM / UNDERLAY
- SURFACE PREPARATION AND LEVELING PRIOR TO INSTALLATION TO ENSURE PERFECT FLATNESS



Feature	Solid Wood	Engineered	Laminate	SPC
Water Resistance	Low	Moderate	Low	Very High
Scratch Resistance	Moderate	Good	High	Very High
Cost Level	High	Medium-High	Economical	Medium
Re-sanding Option	Yes	Limited	No	No
Ideal Use	Luxury Villas	Premium Residential	Offices & Apartments	Wet & Commercial

Solid Wood Parquet

- Thickness: 18 – 22 mm
- 100% natural hardwood layer
- Can be re-sanded multiple times
- Requires proper moisture insulation
- Life Span: 20+ years

Engineered Wood Flooring

- Thickness: 12 – 15 mm
- Natural wood top layer with multi-layer core
- Higher dimensional stability
- Suitable for AC-controlled environments
- Life Span: 15 – 20 years

LAMINATE FLOORING

- **THICKNESS: 8 - 12 MM**
- **SCRATCH-RESISTANT SURFACE LAYER**
- **CLICK SYSTEM INSTALLATION**
- **COST-EFFECTIVE AND EASY MAINTENANCE**
- **LIFE SPAN: 10 - 15 YEARS**

SPC FLOORING

- **THICKNESS: 4 - 6 MM**
- **100% WATERPROOF CORE**
- **RESISTANT TO HUMIDITY AND TEMPERATURE CHANGES**
- **IDEAL FOR KITCHENS AND COMMERCIAL AREAS**
- **LIFE SPAN: 15 - 20 YEARS**





شركة هيرا ميدل إيست
Heera Middle East Company
0563657274 - 0547722446

- Furniture Supply
- Hotel Fit-Out & FF&E
- Interior Solutions

FURNITURE & HOTEL FIT-OUTS

شركة هيرا ميدل إيست
Heera Middle East Company
0563657274 - 0547722446

شركة هيرا ميدل إيست
Heera Middle East Company
0563657274 - 0547722446

شركة هيرا ميدل إيست
Heera Middle East Company
0563657274 - 0547722446

Furniture Solutions

- High-quality furniture supply
- Custom-designed furniture
- Office furniture solutions
- Outdoor and reception furniture
- Luxury beds and bedroom sets
- Tables, chairs, sofas, desks, wardrobes, etc.

Hotel Fit-Out & FF&E

- Comprehensive fit-out services
- Furniture, fixtures & equipment (FF&E)
- Turnkey project management
- Hotel guestroom furnishings
- Lobby, restaurant, and common area design
- Bespoke interior solutions



Furniture Solutions

- High-quality furniture supply
- Custom-made furniture pieces
- Modern office furniture solutions
- Outdoor & reception area furnishings
- Luxury bedroom and living furniture
- Tables, chairs, sofas, desks, wardrobes, etc.

Hotel Fit-Out & FF&E

- Complete fit-out and furnishing services
- Furniture, fixtures and equipment (FF&E)
- Guestroom & suite interior design
- Lobby & common area fit-outs
- Turnkey project management
- Custom interior solution & designs



شركة هيرا ميديل إيست
Heera Middle East Company
Heera Middle East Company
0563657274 - 0547722446



شركة هيرا ميديل إيست
Heera Middle East Company
Heera Middle East Company
0563657274 - 0547722446



شركة هيرا ميديل إيست
Heera Middle East Company
Heera Middle East Company
0563657274 - 0547722446

Furniture Supply & Hotel Fit-Outs

- Comprehensive Fit-Out Solutions
- Luxurious Furniture Supply
- Turnkey FF&E Services



شركة هيرا ميديل إيست
Heera Middle East Company
0563657274 - 0547722446

شركة هيرا ميديل إيست
Heera Middle East Company
0563657274 - 0547722446

شركة هيرا ميديل إيست
Heera Middle East Company
0563657274 - 0547722446

Furniture Solutions

High-quality, stylish furniture tailored for residential, commercial, and hospitality environments. Our offerings include:

- Custom-designed and modern furniture pieces
- Elegant office furniture setups
- Luxury bedroom and living room furnishings
- Desks, chairs, sofas, beds, tables, etc.

Hotel Fit-Out Services

Complete fit-out solutions for hotels and resorts that include:

- Turnkey FF&E services
- Guestroom and suite furnishings
- Lobby and common area design
- Restaurant and conference room setups
- Custom fixtures, lighting, and decor
- Project management and installation



Furniture Solutions

- Custom-designed and modern furniture pieces
- Elegant office furniture setups
- Luxury bedroom and living room furnishings
- Outdoor and reception area furniture
- Desks, chairs, sofas, beds, tables, etc.

Hotel Fit-Out Services

- Turnkey FF&E services
- Guestroom and suite furnishings
- Lobby and common area design
- Restaurant and conference room setups
- Custom fixtures, lighting, and decor
- Project management and installation



وزارة التجارة
Ministry of Commerce



شهادة السجل التجاري

شركة هيرا ميدل إيست

Heera Middle East Company

0563657274 - 0547722446

البيانات الأساسية للسجل التجاري



7051546872

شركة هيرا ميدل إيست

Heera Middle East Company

0563657274 - 0547722446

شركة هيرا ميدل إيست

الرقم الوطني الموحد: 7051546872

تاريخ الإصدار: 09/09/2025

نوع الكيان: شركة ذات مسؤولية محدودة

صفات الشركة: (شخص واحد)

حالة السجل: نشط

@Xfyt
mcgovsa

1900
mc.gov.sa

شركة هيرا ميدل إيست
Heera Middle East Company
0563657274 - 0547722446

شركة هيرا ميدل إيست
Heera Middle East Company
0563657274 - 0547722446

منشآت
monsha'at
الهيئة العامة للمنشآت الصغيرة والمتوسطة
Small & Medium Enterprises General Authority

غرفة مكة المكرمة
Makkah Chamber
للمسؤولية الأعمال والمصنعة

شهادة انتساب شركة هيرا ميدل إيست

Heera Middle East Company

شركة هيرا ميدل إيست

شركة هيرا ميدل إيست

Heera Middle East Company

0563657274 - 0547722446

التاريخ / 16/09/2025 م

تاريخ الانتهاء / 08/09/2026 م الموافق 26/03/1448 هـ

السجل التجاري رقم / 7051546872

شركة هيرا ميدل إيست

Heera Middle East Company

0563657274 - 0547722446

شركة هيرا ميدل إيست

Heera Middle East Company

0563657274 - 0547722446

الدرجة / السنادية

رقم المنشأة / 7051546872

لصاحبها / عبدالرحمن سعد عبدالعزيز محمد

عنوانه / اسم المدينة : مكة المكرمة - رقم المبنى : 7791 - الرمز البريدي : 24236 - الرقم الاضافي : 3368
ص.ب / 24236

مدير إدارة المنتسبين

هيثم بن عبدالله المنابري

شركة هيرا ميدل إيست

Heera Middle East Company

0563657274 - 0547722446

الختم



شركة هيرا ميدل إيست

Heera Middle East Company

0563657274 - 0547722446

نسخة إلكترونية رقم 202011208779 يمكنك التحقق منها عن طريق



شركة هيرا ميدل إيست

Heera Middle East Company

0563657274 - 0547722446



أمانة العاصمة المقدسة
HOLY MAKKAH MUNICIPALITY



خدمات
بلدي
balady
services



شركة هيرا ميدل إيست
Heera Middle East Company
0563657274 - 0547722446

شركة هيرا ميدل إيست
Heera Middle East Company
0563657274 - 0547722446

شركة هيرا ميدل إيست
Heera Middle East Company
0563657274 - 0547722446

رخصة نشاط تجاري Commercial Activity Licence شركة هيرا ميدل إيست

License Expiry Date	تاريخ نهاية الترخيص	License Number	رقم الرخصة الموحد
1449/05/26		470521580556	

Owner's Name	اسم المالك
شركة هيرا ميدل إيست Heera Middle East Company 0563657274 - 0547722446	شركة هيرا ميدل إيست Heera Middle East Company 0563657274 - 0547722446

Owner's ID	رقم هوية المالك
	7051546872

ISIC Classification	التصنيف الصناعي القياسي الدولي (نشاط ايزك)
	الإنشاءات العامة للمباني السكنية

Detailed Activity	النشاط التفصيلي
	الإنشاءات العامة للمباني السكنية

Sub-Municipality	البلدية	Municipality	الأمانة
بلدية الشوقية الفرعية		أمانة العاصمة المقدسة	

Street	الشارع	District	الحي
الرصيفة 13		حي الرصيفة	

Sign's Area	مساحة اللوحة	Sign's Type	نوع اللوحة	Shop's Total Area	مساحة المحل الإجمالية
1		إرشادية		75 متر مربع	
				شركة هيرا ميدل إيست Heera Middle East Company 0563657274 - 0547722446	
				للاطلاع على الأنشطة الإضافية وتفاصيل الرخصة يرجى مسح رمز الاستجابة السريعة Code QR	
				موقع المحل	

Permit Expiry Date	تاريخ انتهاء التصريح	Permit Number	رقم التصريح	Permits	التصاريح

مركز العناية بالعملاء
199040

Balady_cs

شركة هيرا ميدل إيست
Heera Middle East Company
0563657274 - 0547722446

saudimomra

www.balady.gov.sa

OUR CLIENTS

Saudiicon
شركة الرمز السعودي



الهيئة الملكية لمدينة مكة
'مكرمة والمشاعر المقدسة'
ROYAL COMMISSION FOR
AKKAH CITY AND HOLY SITE



مجموعة بن لادن السعودية
SAUDI BINLADIN GROUP



كداينة
KIDANA

COMPASS Contracting™
المدور للمقاولات



عبد اللطيف جميل
للخدمات اللوجستية



وزارة الحج و العمرة
'Ministry of Hajj & Umrah'



وزارة الشؤون البلدية
و القروية والإسكان
'istry of Municipal Rural Affairs & Hous'



أمانة العاصمة المقدسة
HOLY MAKKAH MUNICIPALITY

ثروات الرائدة
العقارية
THARAWAT
LEADING
REAL ESTATE



فقيه
مستشفى د. سليمان فقيه
Dr. Soliman Fakeeh Hospital



شركة مجموعة الفؤاد
Alfouad Group Company



SKAB
Arabian



مصدر
Building Materials
المواد البناء

isela



فريسينيه
Freyssinet
SAUDI ARABIA



بالبيت
Balubaid



UNITED
CONSTRUCTORS
CONTRACTING CO. LTD.
شركة المتحدة للمقاولات



جدة
للإستثمارات العقارية



شركة الصعيد العامة للمقاولات

شركة هيرا ميدل إيست
Heera Middle East Company
0563657274 - 0547722446

شركة هيرا ميدل إيست
Heera Middle East Company
0563657274 - 0547722446

شركة هيرا ميدل إيست
Heera Middle East Company
0563657274 - 0547722446

054 772 2446

www.heeramiddleeast.com

info@heeramiddleeast.com

OUR CLIENTS

شركة هيرا ميدل إيست
Heera Middle East Company
0563657274 - 0547722446

MBL
Modern Building Leaders
شركة قادة البناء الحديث

شركة هيرا ميدل إيست
Heera Middle East Company
0547722446

MOBCO

شركة هيرا ميدل إيست
Heera Middle East Company
0563657274 - 0547722446
www.job-ar.com

جبل إدساس
JABAL EDSAS



غرفة مكة المكرمة
Mekkah Chamber
للمهنة والاعمال والتجارة



الراجحي
AL-RAGHY FOR REAL ESTATE INVESTMENTS
AND COMMERCIAL AGENCIES

شركة هيرا ميدل إيست
Heera Middle East Company
0563657274 - 0547722446



GIC
Ghonaim International Co.
شركة غنيم الدولية

شركة هيرا ميدل إيست
Heera Middle East Company
0563657274 - 0547722446



ELALAMEYA
INVESTMENT & REAL ESTATE
الشركة العالمية للتطوير العقاري

شركة هيرا ميدل إيست
Heera Middle East Company
0563657274 - 0547722446



AI-RAJHI
Building & Constructions



أزهر
شركة أزهر
AZHAR COMPANY

جدة بارك
JEDDAH PARK

شركة هيرا ميدل إيست
Heera Middle East Company
0563657274 - 0547722446

رؤك المدينة القابضة
Rua Al Madinah Holding

شركة هيرا ميدل إيست
Heera Middle East Company
0563657274 - 0547722446



شركة رؤى
الحرم المكي
RUA ALHARAM ALMAKKI CO.

شركة هيرا ميدل إيست
Heera Middle East Company
0563657274 - 0547722446



SEVEN
SAUDI ENTERTAINMENT VENTURES



مجموعة المرجان
AL MURJAN GROUP



المؤسسة العامة للتقاعد

شركة هيرا ميدل إيست
Heera Middle East Company
0563657274 - 0547722446

SAS

GROUP
REAL ESTATE
مجموعة ساس العقار

شركة هيرا ميدل إيست
Heera Middle East Company
0563657274 - 0547722446



GCG
GHAYA
Construction Group
مجموعة غاية للمقاولات

شركة هيرا ميدل إيست
Heera Middle East Company
0563657274 - 0547722446



ETROJET
إتروجت



شركة أشي وبشناق للمقاولات
Ashi & Bushnag Co. for Contracting
مساهمة مقفلة | Closed Joint Stock



مجموعة علي الصاعدي المحدودة للمقاولات
Al-Saadi Contracting Ltd. Group

شركة هيرا ميدل إيست
Heera Middle East Company
0563657274 - 0547722446

شركة هيرا ميدل إيست
Heera Middle East Company
0563657274 - 0547722446

شركة هيرا ميدل إيست
Heera Middle East Company
0563657274 - 0547722446

054 772 2446

www.heeramiddleeast.com

info@heeramiddleeast.com



HEERA MIDDLE



شركة هيرا ميدل إيست

Heera Middle East Company

0563657274 - 0547722446

شركة هيرا ميدل إيست

Heera Middle East Company

0563657274 - 0547722446

شركة هيرا ميدل إيست

Heera Middle East Company

0563657274 - 0547722446

EAST COMPANY

CONCLUSION

شركة هيرا ميدل إيست

Heera Middle East Company

We look forward to contributing to your upcoming projects and delivering excellence that reflects your vision and operational needs.

شركة هيرا ميدل إيست

Heera Middle East Company

0563657274 - 0547722446

شركة هيرا ميدل إيست

Heera Middle East Company

0563657274 - 0547722446

شركة هيرا ميدل إيست

Heera Middle East Company

0563657274 - 0547722446

شركة هيرا ميدل إيست

Heera Middle East Company

0563657274 - 0547722446

شركة هيرا ميدل إيست

Heera Middle East Company

0563657274 - 0547722446

شركة هيرا ميدل إيست

Heera Middle East Company

0563657274 - 0547722446

شركة هيرا ميدل إيست

Heera Middle East Company

0563657274 - 0547722446

شركة هيرا ميدل إيست

Heera Middle East Company

0563657274 - 0547722446

CONTACT US

برج الشريف يحيى تايم تاور - دور 10 - مكتب رقم 1 - الدائري الثالث - حي الخالدية - مكة المكرمة

Al Sharif Yahya Time Tower - Third Ring Road - Makkah - Al Rusayfah District



054 772 2446



www.heeramiddleeast.com



info@heeramiddleeast.com